

# SISTEMAS CORREDIZOS PARA BAÑO

**IntegraGlass** 

Fabricación de herrajes para vidrio

Sistemas corredizos para cristal templado

ECATEPEC | PACHUCA | TECÁMAC

 55 2114 8055

   @herrajesazteca

 contacto@herrajesazteca.com.mx

 www.herrajesazteca.com.mx

**HA**   
**HERRAJES AZTECA**

IntegraGlass 

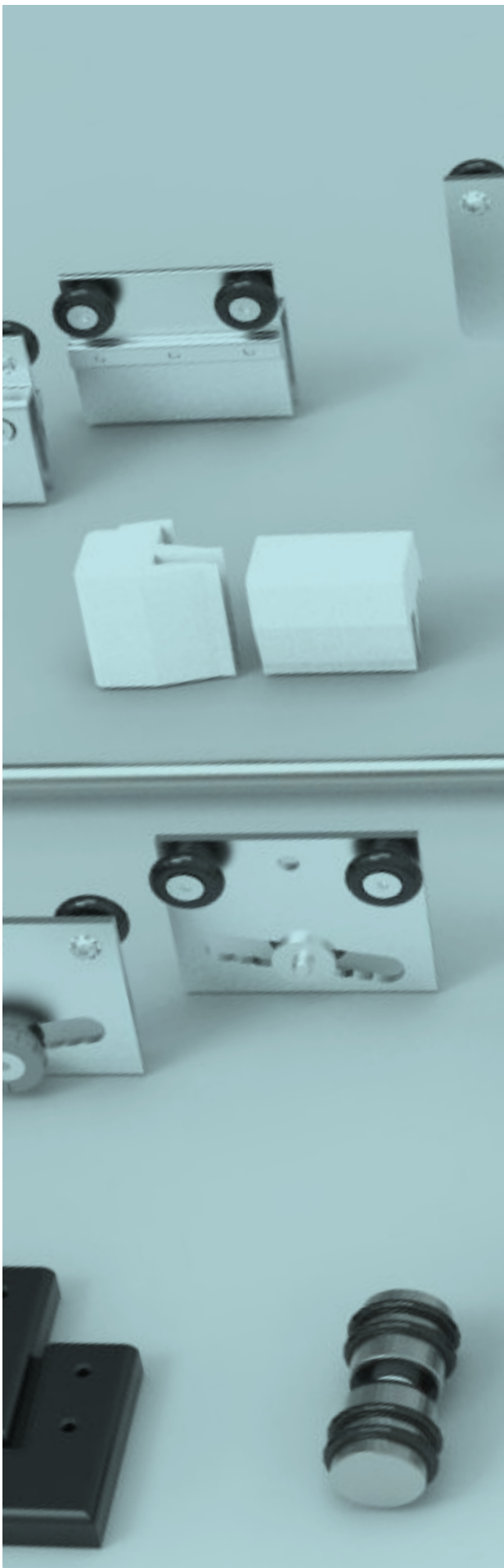

# QUIÉNES SOMOS

Integra Glass es una empresa 100% mexicana respaldada por 25 años de experiencia en el mercado fabricando soluciones para aluminio y vidrio.

Contamos con una planta de procesos en la que ofrecemos servicios de pintura electrostática y/o sublimado en herrajes para vidrio, aluminio, perfiles de aluminio y/o acero en líneas comerciales e industriales con capacidad de hasta 3.8 metros lineales en 25 acabados de línea, así como la aplicación de colores especiales sobre proyecto.

Disponemos con maquinaria y un departamento de ingeniería para brindar un servicio de diseño y manufactura de herrajes especiales en aluminio, acero o inyección de plástico, enfocado al desarrollo de sus proyectos.

Nuestro producto líder como fabricantes es el sistema corredizo de baño para cristal templado, en el cual nuestros sistemas de rodamiento son ensamblados con componentes de excelente calidad y alta resistencia a la corrosión, validados bajo norma ASTM B 117-16.

Garantizamos la más alta calidad en todos los productos que fabricamos y comercializamos, ofreciendo seriedad en nuestros servicios como institución de prestigio.

## MISIÓN

Desarrollamos continuamente a nivel personal y profesional en una constante mejora continua de nuestras capacidades y valores tangibles e intangibles, logrando un alto nivel de confianza y satisfacción de nuestros clientes directos e indirectos.

## VISIÓN

Ser un equipo de trabajo funcional y cohesionado que converja a ser líderes en la fabricación y distribución de sistemas corredizos para cristal templado en México.

## VALORES

**Empatía**

**Humildad**

**Hambre**

## VALORES COMPETITIVOS



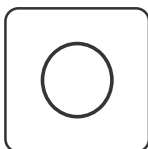

SISTEMA CON  
BARRENO

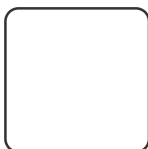

SISTEMA SIN  
BARRENO



AJUSTE EN  
DESCUADRE



MEDIDAS  
ESPECIALES



RODAMIENTO  
ANTICORROSIVO

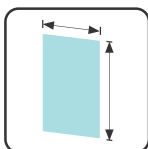

MEDIDAS  
1.20 x 2.00 Mts.  
1.50 x 2.00 Mts.  
2.00 x 2.00 Mts.

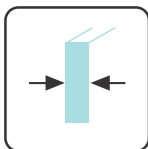

ESPESOR  
DEL VIDRIO  
6 mm  
(1/4)



ESPACIO  
ENTRE HOJAS  
15 mm



# Acuario

Sistema corredizo para baño con vidrio de 6 mm

# Sistema Corredizo con Perfilera Perimetral



**NOTA.**  
La instalación de nuestros sistemas corredizos con Perfilera Perimetral, exigen ser a escuadra y a nivel para una mayor eficiencia.



**MEDIDAS ESTANDAR:** 1.20 x 2.00 Mts. / 1.50 x 2.00 Mts. / 2.00 x 2.00 Mts.

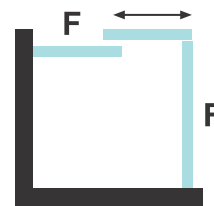
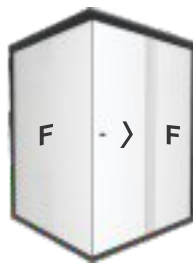
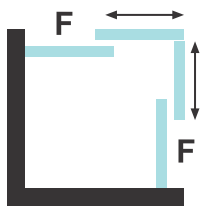

**MEDIDAS ESTANDAR:** 1.00 x 2.00 Mts. / 1.20 x 2.00 Mts.

## Medidas

Riel Superior  
A) 76 mm  
B) 69 mm

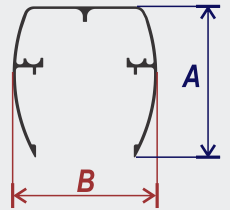

Jamba Lateral  
A) 16 mm  
B) 46 mm

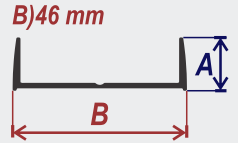

Riel Inferior  
A) 19 mm  
B) 42 mm

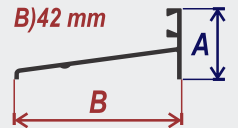

# Sistema Corredizo Línea Diamante



**MEDIDAS ESTANDAR:** 1.20 x 2.00 Mts. / 1.50 x 2.00 Mts. / 2.00 x 2.00 Mts.

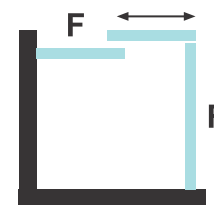
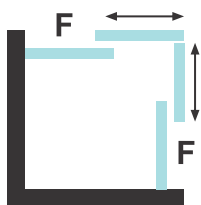

**MEDIDAS ESTANDAR:** 1.00 x 2.00 Mts. / 1.20 x 2.00 Mts.

## Medidas

Riel Superior  
A) 76 mm  
B) 69 mm

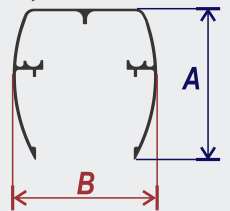

## RIEL INFERIOR TRANSPARENTE



A) 19 mm  
B) 42 mm

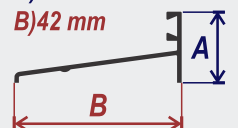

**NOTA.** La instalación de nuestros sistemas corredizos sin Jamba Lateral y en nuestra Línea Diamante, exigen ser a plomo y a escuadra para una mayor eficiencia.

# Descuentos para Hoja de Vidrio Sistema Corredizo con Perfilera Perimetral

**F1**  
Distancia de la base del centrador a la base superior del Riel

**F2**  
Distancia de la base a ras de suelo a la base de asentamiento de la guía inferior.

**F3**  
Holgura entre base superior y vidrio

**F4**  
Holgura entre piso y vidrio

**Traslape de vidrio.**  
Ancho del cristal  
(Base ÷ 2) + (25 mm).

**Nota:**  
El descuento para la altura de las hojas fijas, es igual a la suma de "F1" y "F2"

El descuento para la altura de las hojas corredizas, es igual a la suma de "F3" y "F4"

**DESCUENTO PARA LA ALTURA DE LA JAMBA UNIVERSAL**

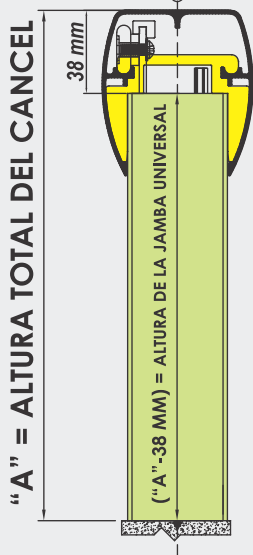

**Carretilla Oculta (CON BARRENO)**

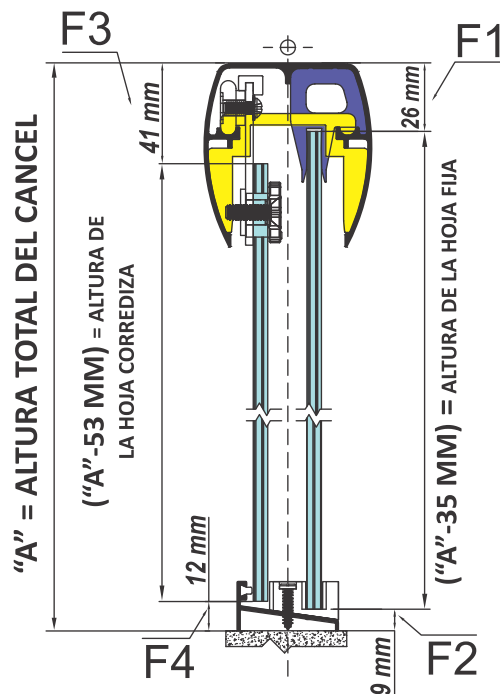

**Carretilla Expuesta (CON BARRENO)**

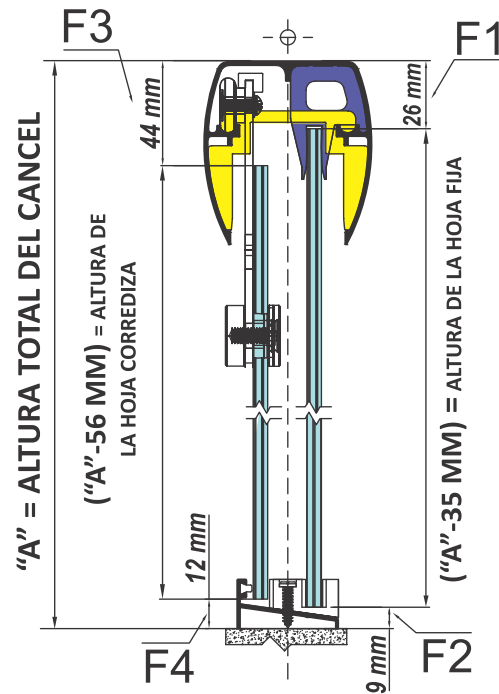

**Carretilla A presión dos rodamientos (SIN BARRENO)**

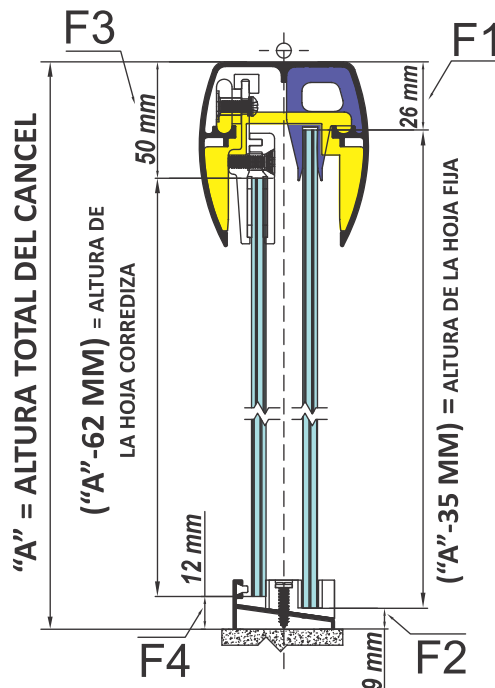

**Carretilla A presión un rodamiento (SIN BARRENO)**

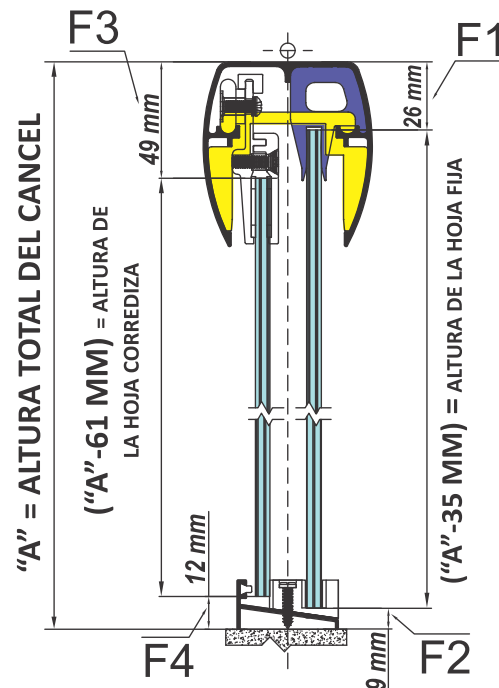

# Descuentos para Hoja de Vidrio Línea Diamante



**Carretilla Oculta  
(CON BARRENO)**

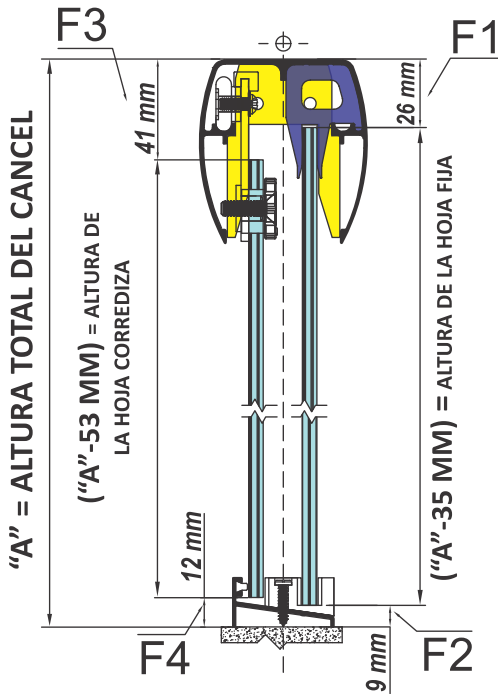

**Carretilla Expuesta  
(CON BARRENO)**

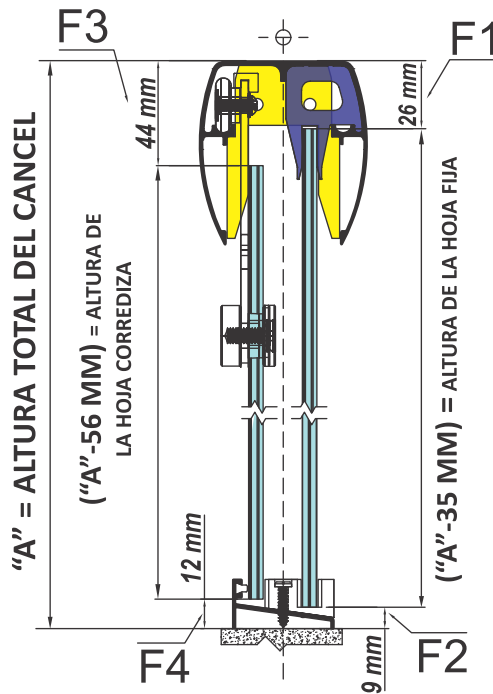

**Carretilla A presión  
dos rodamientos  
(SIN BARRENO)**

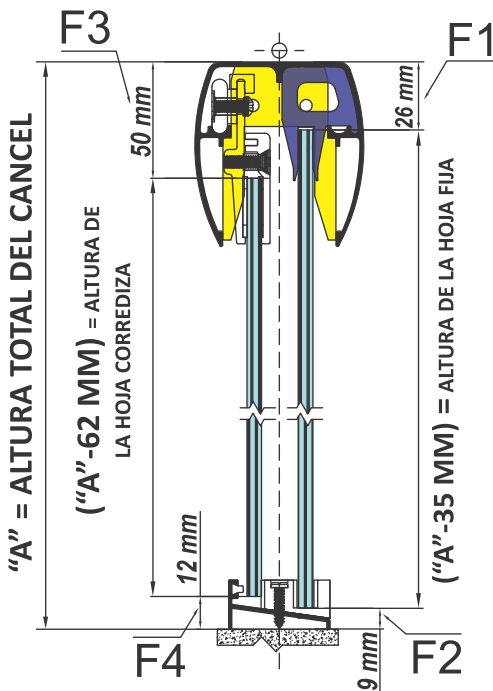

**Carretilla A presión  
un rodamiento  
(SIN BARRENO)**

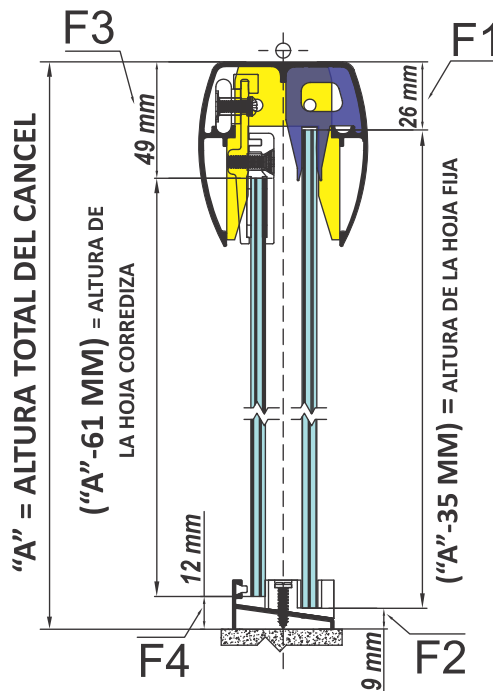

- F1**  
Distancia de la base del centrador a la base superior del Riel
- F2**  
Distancia de la base a ras de suelo a la base de asentamiento de la guía inferior.
- F3**  
Holgura entre base superior y vidrio
- F4**  
Holgura entre piso y vidrio

**Traslape de vidrio.**  
Ancho del cristal  
(Base ÷ 2) + (25 mm).

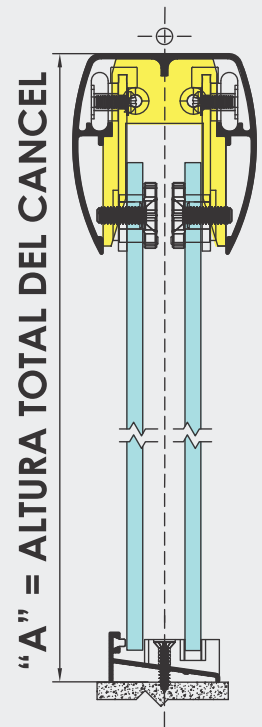

**RIEL OPCIONAL DE ALUMINIO**



**SEGURIDAD** **CONFIANZA**  
**EVITA RIESGOS Y ACCIDENTES**  
**EVITA DESPLAZAMIENTO DEL VIDRIO**

ES LO QUE OFRECE NUESTRA NUEVA VERSIÓN  
DE CARRETILLA SIN BARRENO DE 6 MM



SISTEMA DE UNIÓN POR  
JUNTA DE **ENCASTRE**



PRESIÓN UNIFORME  
A TRÁVES DE **3**  
**TORNILLOS**



CON SISTEMA DE CÁMARA  
DE PRESIÓN, EVITE PONER  
**PEGAMENTO** AL NEOPRENO



Carretillas de uno y dos  
rodamientos a presión.



# Aries

Sistema corredizo para baño con vidrio de 6 mm

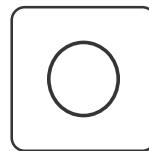

SISTEMA CON  
BARRENO



SISTEMA SIN  
BARRENO



AJUSTE EN  
DESCUADRE



MEDIDAS  
ESPECIALES



RODAMIENTO  
ANTICORROSIVO

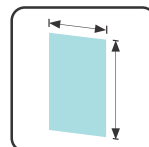

MEDIDAS  
1.20 x 2.00 Mts.  
1.50 x 2.00 Mts.  
2.00 x 2.00 Mts.

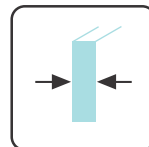

ESPESOR  
DEL VIDRIO  
6 mm  
(1/4)



ESPACIO  
ENTRE HOJAS  
15 mm



# Sistema Corredizo con Perfilera Perimetral

## Medidas

Riel Superior

A) 76 mm

B) 69 mm

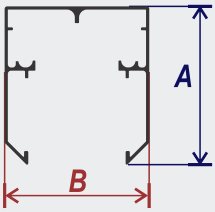

Jamba Lateral

A) 16 mm

B) 46 mm

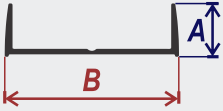

Riel Inferior

A) 19 mm

B) 42 mm



**NOTA.**  
La instalación de nuestros sistemas corredizos con Perfilera Perimetral, exigen ser a escuadra y a nivel para una mayor eficiencia.

**MEDIDAS ESTANDAR:** 1.20 x 2.00 Mts. / 1.50 x 2.00 Mts. / 2.00 x 2.00 Mts.

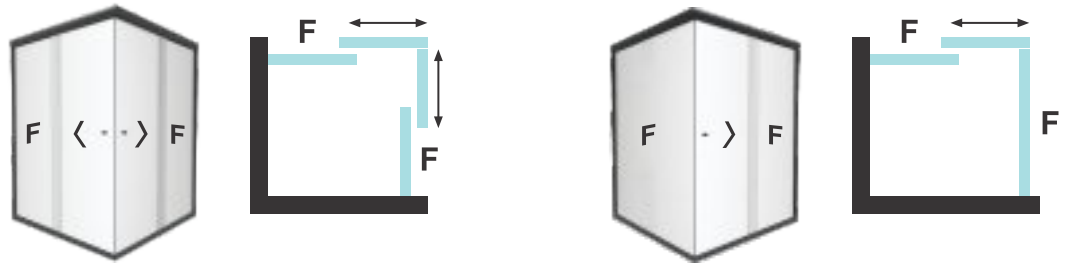

**MEDIDAS ESTANDAR:** 1.00 x 2.00 Mts. / 1.20 x 2.00 Mts.

# Sistema Corredizo Línea Diamante

## Medidas

Riel Superior

A) 76 mm

B) 69 mm

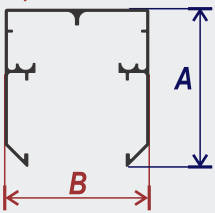

**MEDIDAS ESTANDAR:** 1.20 x 2.00 Mts. / 1.50 x 2.00 Mts. / 2.00 x 2.00 Mts.

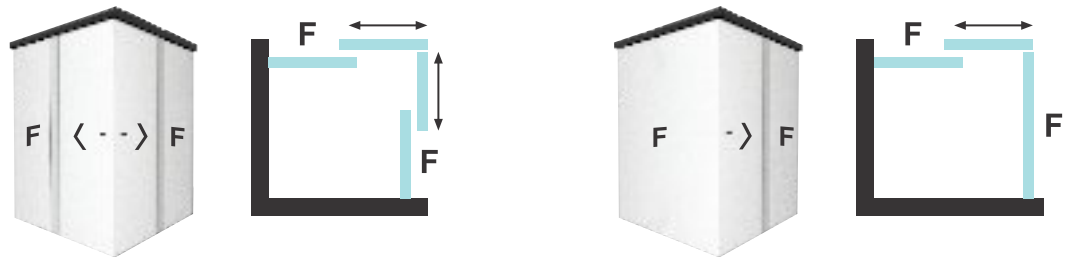

**MEDIDAS ESTANDAR:** 1.00 x 2.00 Mts. / 1.20 x 2.00 Mts.

## RIEL INFERIOR TRANSPARENTE

A) 19 mm

B) 42 mm



**NOTA.** La instalación de nuestros sistemas corredizos sin Jamba Lateral y en nuestra Línea Diamante, exigen ser a plomo y a escuadra para una mayor eficiencia.



**Carretilla Oculta  
(CON BARRENO)**

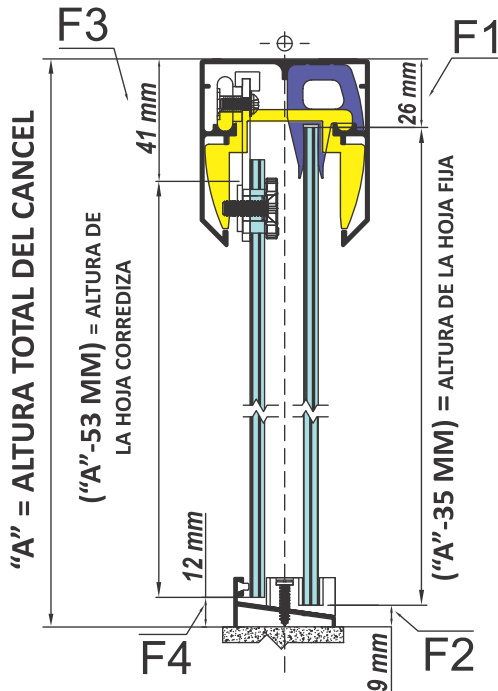

**Carretilla Expuesta  
(CON BARRENO)**

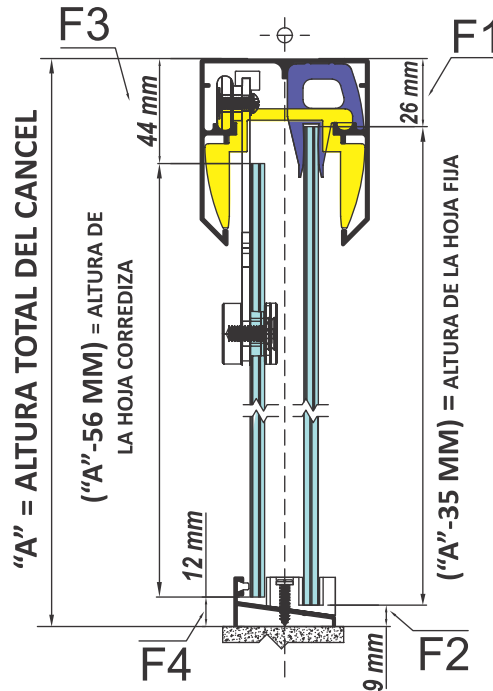

**Carretilla A presión  
dos rodamientos  
(SIN BARRENO)**

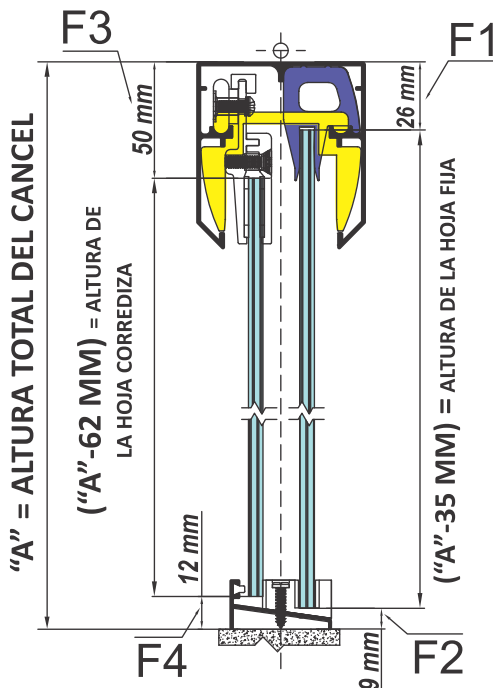

**Carretilla A presión  
un rodamiento  
(SIN BARRENO)**

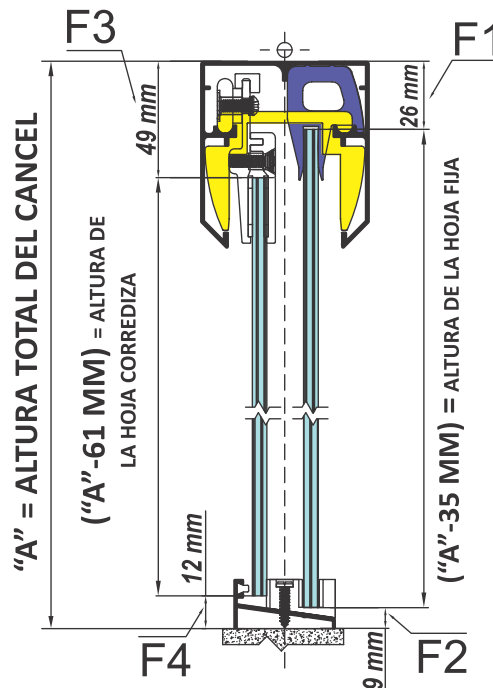

**F1**  
Distancia de la base del centrador a la base superior del Riel

**F2**  
Distancia de la base a ras de suelo a la base de asentamiento de la guía inferior.

**F3**  
Holgura entre base superior y vidrio

**F4**  
Holgura entre piso y vidrio

**Traslape de vidrio.**  
Ancho del cristal  
(Base + 2) + (25mm).

**Nota:**

El descuento para la altura de las hojas fijas, es igual a la suma de "F1" y "F2"

El descuento para la altura de las hojas corredizas, es igual a la suma de "F3" y "F4"

**DESCUENTO PARA LA ALTURA DE LA JAMBA UNIVERSAL**

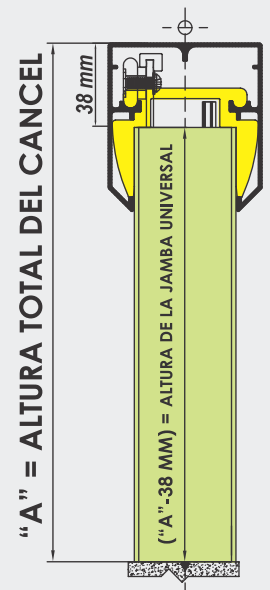

# Descuentos para Hoja de Vidrio Línea Diamante

## F1

Distancia de la base del centrador a la base superior del Riel

## F2

Distancia de la base a ras de suelo a la base de asentamiento de la guía inferior.

## F3

Holgura entre base superior y vidrio

## F4

Holgura entre piso y vidrio

## Traslape de vidrio.

Ancho del cristal (Base+ 2) + (25mm).

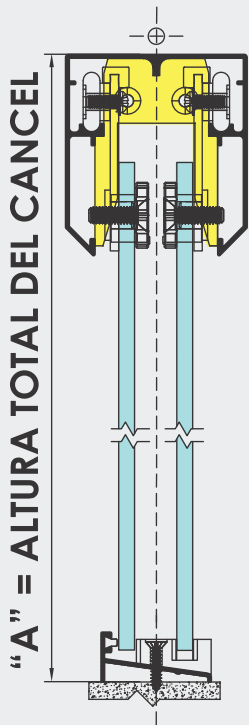

### Carretilla Oculta (CON BARRENO)

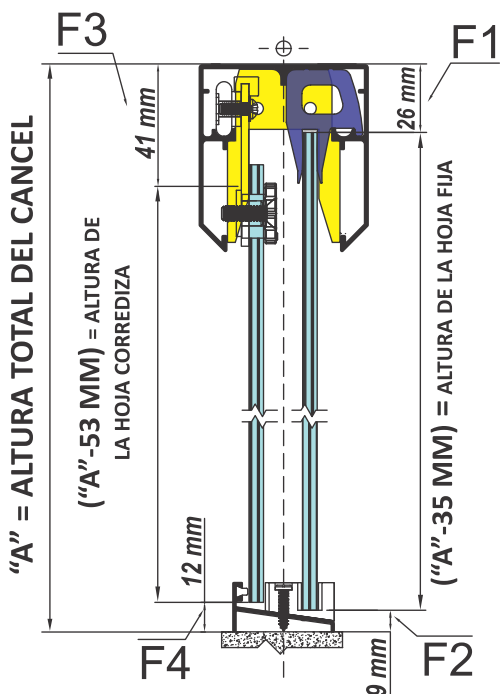

### Carretilla Expuesta (CON BARRENO)

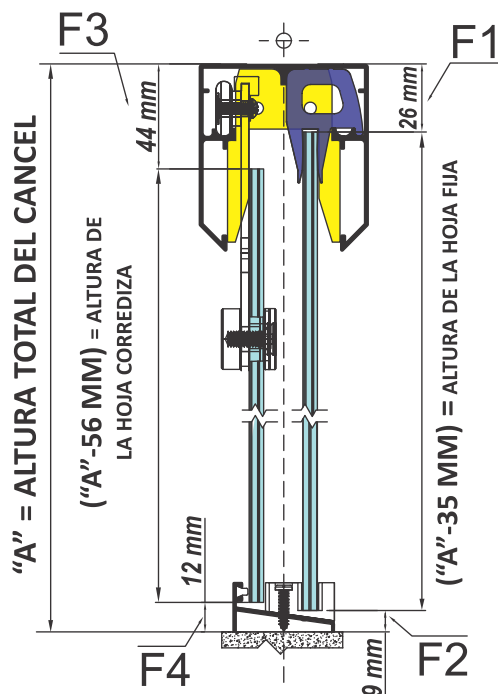

### Carretilla A presión dos rodamientos (SIN BARRENO)

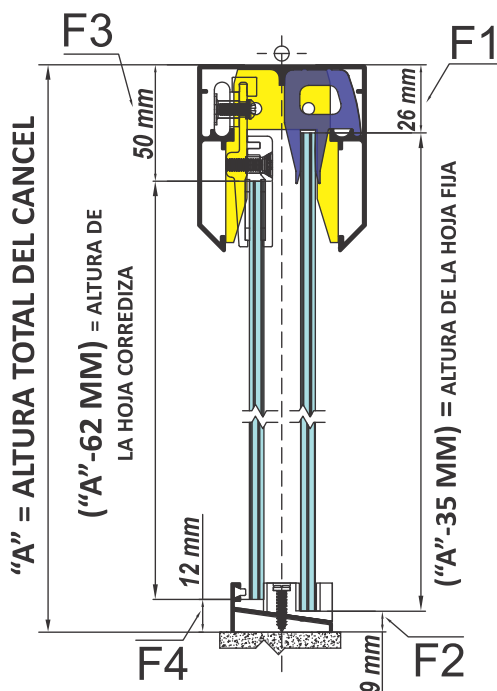

### Carretilla A presión un rodamiento (SIN BARRENO)

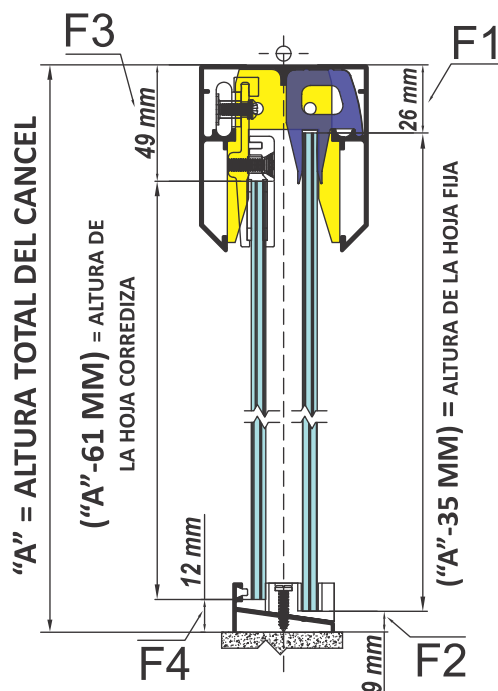

RIEL OPCIONAL DE ALUMINIO

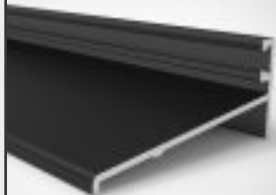

# Corte y Alzado Cancel Recto Corredizo/Corredizo

1 RIEL SUPERIOR

2 RIEL INFERIOR

3 JAMBA LATERAL

4 TOPE DE SEGURIDAD

5 CARRETILLA OCULTA

6 GUÍA INFERIOR DE 6 mm

7 JALADERA POMO DE 6 mm

8 PORTA JAMBA

9 TOPE LATERAL

10 PIJAS Y TAQUETES

11 MOLDURA DE TRASLAPE DE 6 mm

Compatible con:

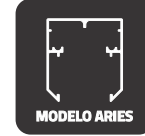

Cancel Recto Corredizo/Corredizo

## CORTE LATERAL B-B'

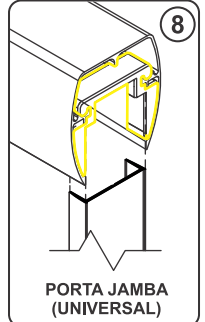
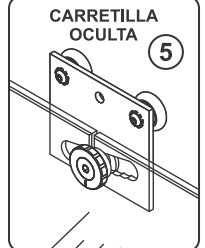
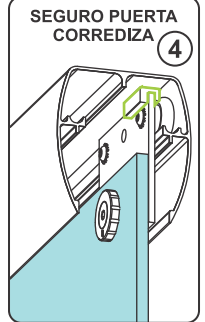
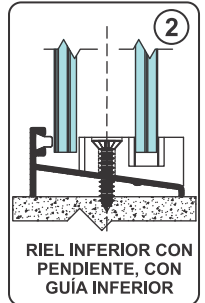
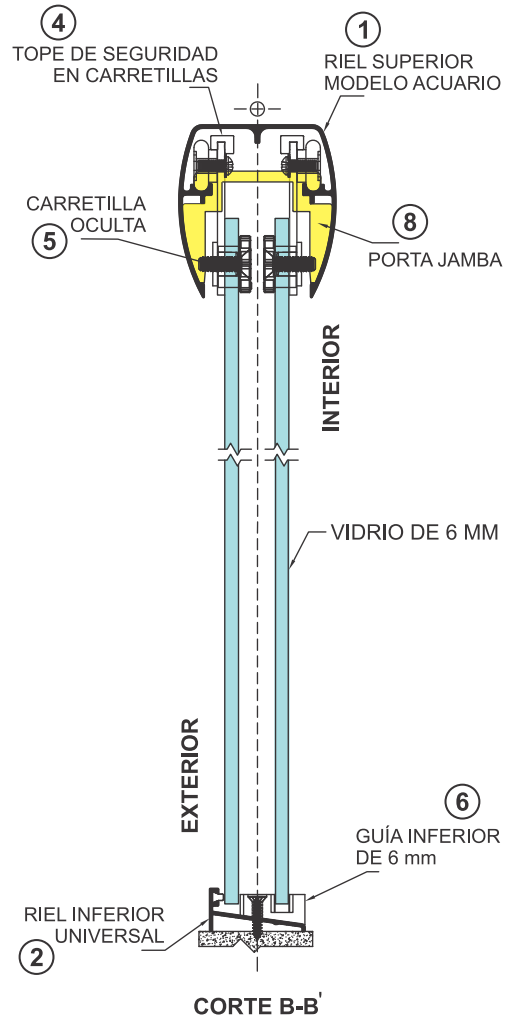

## CORTE SUPERIOR A-A'

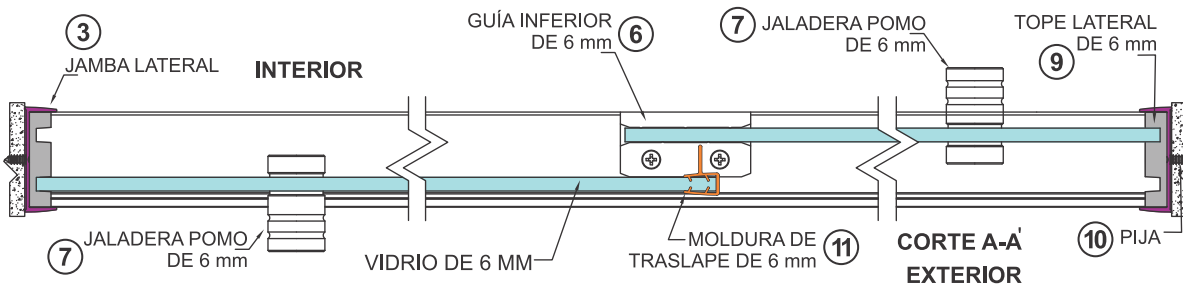

# Corte y Alzado Cancel Recto Corredizo/Fijo Interior



Cancel Recto Corredizo/Fijo Interior

Compatible con:

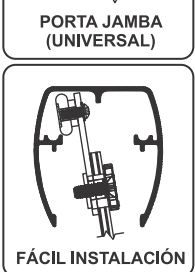
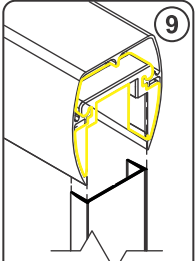
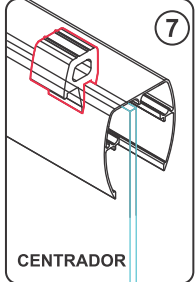
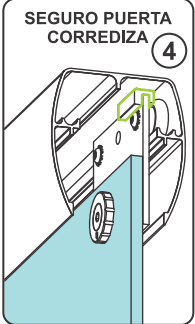
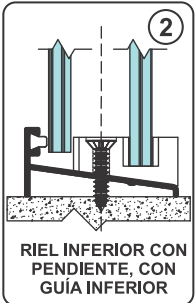
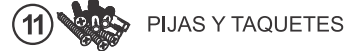
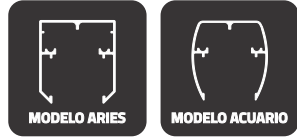

## CORTE LATERAL B-B'

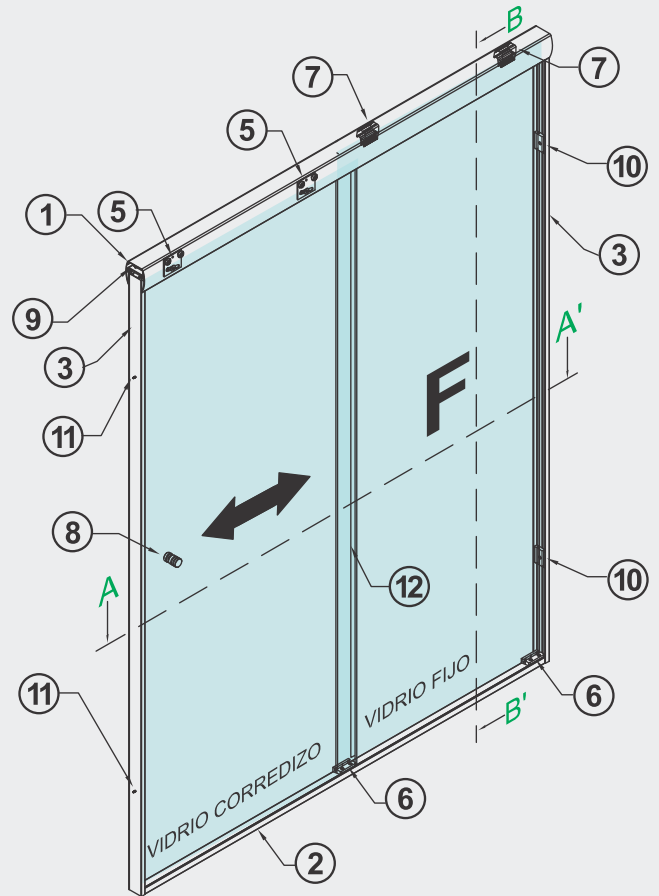
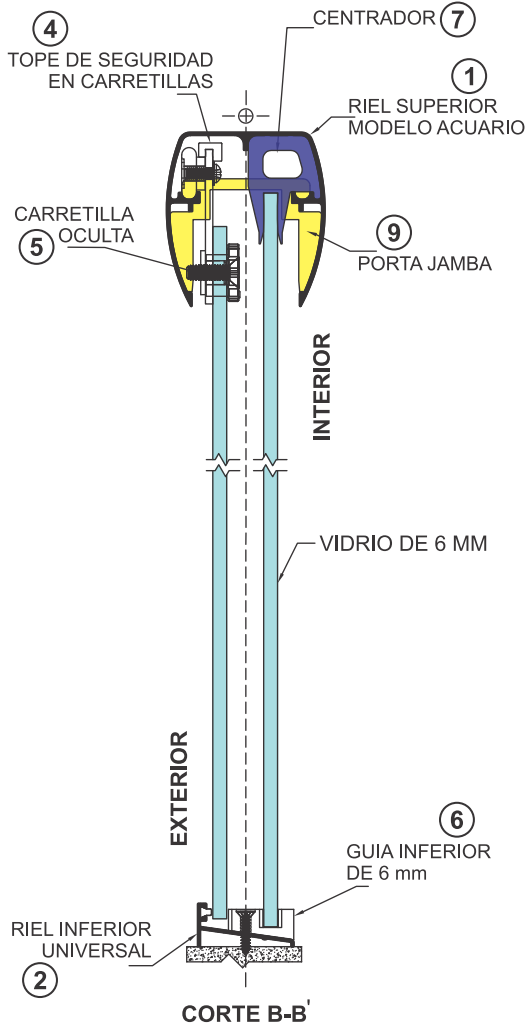

## CORTE SUPERIOR A-A'

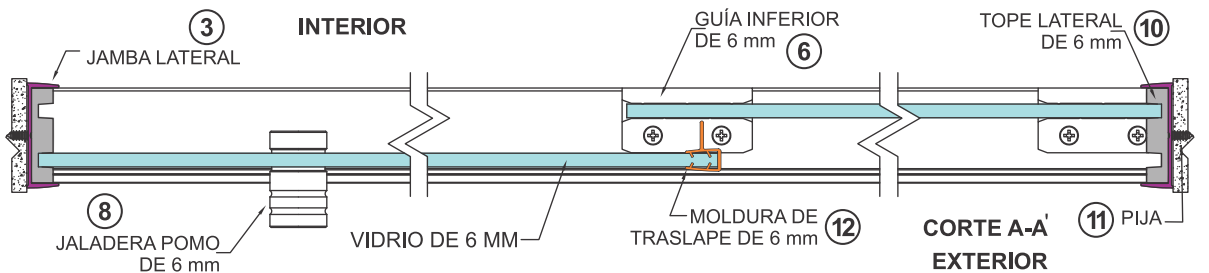

# Corte y Alzado Cancel Recto Fijo Exterior/Corredizo

- ①  RIEL SUPERIOR
- ②  RIEL INFERIOR
- ③  JAMBA LATERAL
- ④  TOPE DE SEGURIDAD
- ⑤  CARRETILLA OCULTA
- ⑥  GUÍA INFERIOR DE 6 mm

- ⑦  CENTRADOR
- ⑧  JALADERA POMO DE 6 mm
- ⑨  PORTA JAMBA
- ⑩  TOPE LATERAL
- ⑪  SOPORTE PARA VIDRIO FIJO AL EXT.

Compatible con:

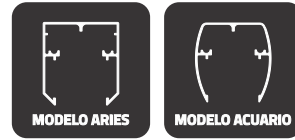

- ⑫  PIJAS Y TAQUETES
- ⑬  MOLDURA DE TRASLAPE DE 6 mm



Cancel Recto Corredizo/Fijo Exterior

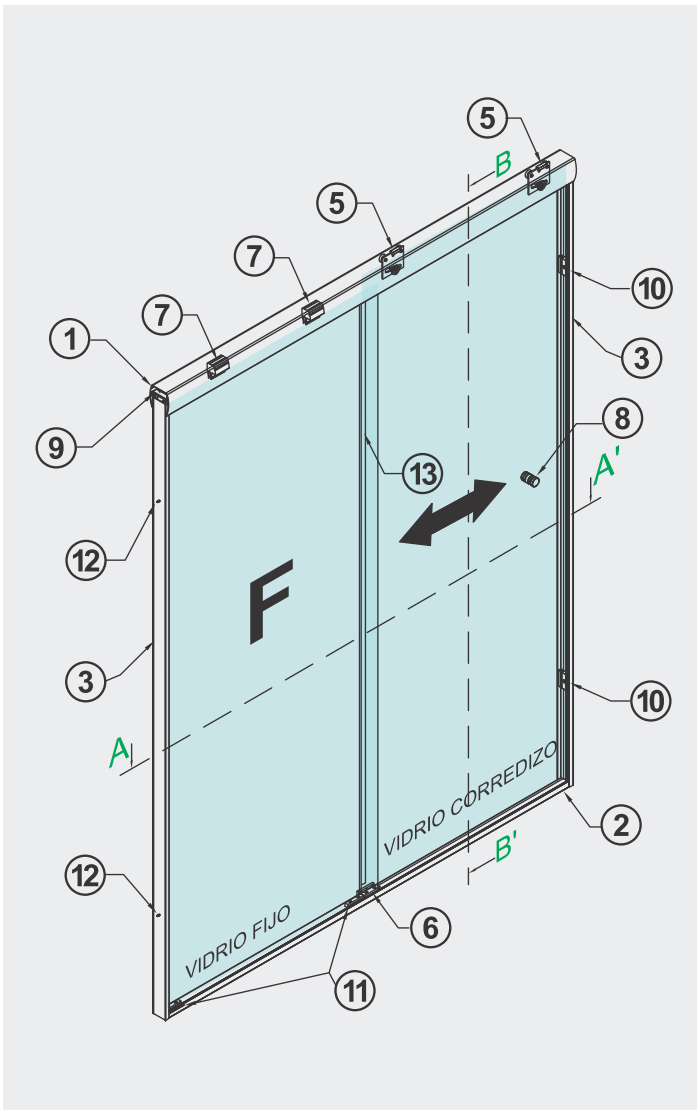

## CORTE LATERAL B-B'

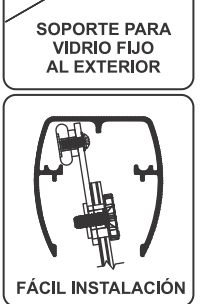
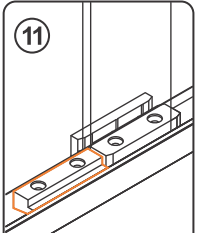
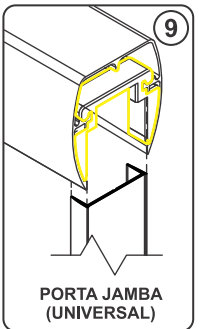
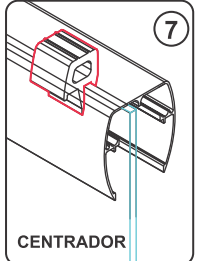
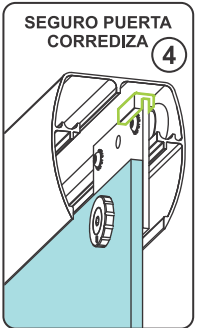
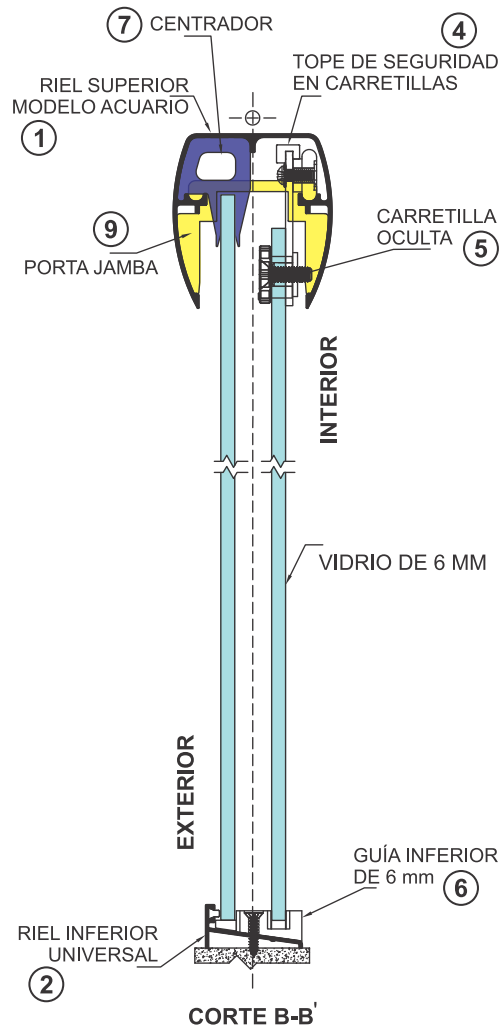

## CORTE SUPERIOR A-A'

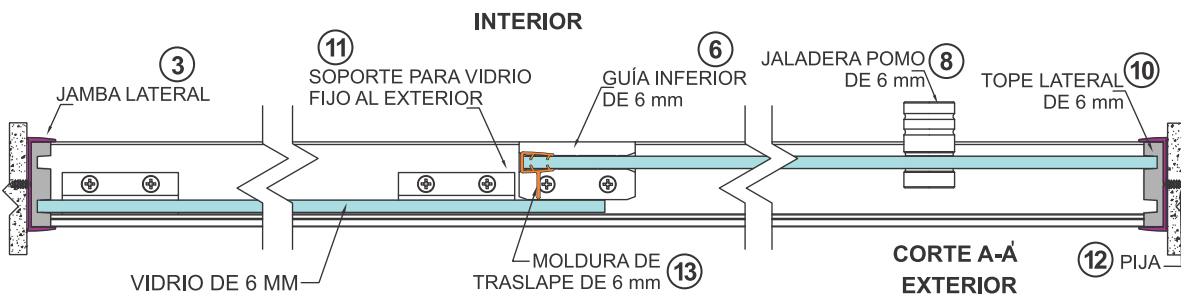

# Corte y Alzado Cancel en Escuadra Fijo Exterior/Corredizo-Corredizo/Fijo Exterior

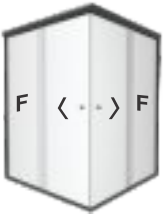

Cancel en Escuadra Fijo Exterior/Corredizo-Corredizo/Fijo Exterior

Compatible con:

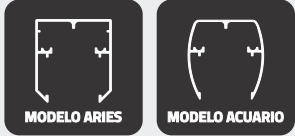

- ① RIEL SUPERIOR
- ② RIEL INFERIOR
- ③ JAMBA LATERAL
- ④ MOLDURA IMÁN
- ⑤ ESCUADRA SUPERIOR
- ⑥ ESCUADRA INFERIOR
- ⑦ TOPE LATERAL
- ⑧ SOPORTE PARA RIEL SUPERIOR CON JAMBA
- ⑨ PORTA JAMBA
- ⑩ TOPE DE SEGURIDAD
- ⑪ CARRETILLA OCULTA
- ⑫ GUÍA INFERIOR DE 6 mm
- ⑬ JALADERA POMO DE 6 mm
- ⑭ CENTRADOR
- ⑮ SOPORTE PARA VIDRIO FIJO AL EXTERIOR
- ⑯ PIJAS Y TAQUETES
- ⑰ MOLDURA DE TRASLAPE DE 6 mm

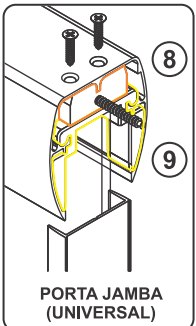
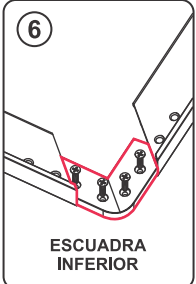
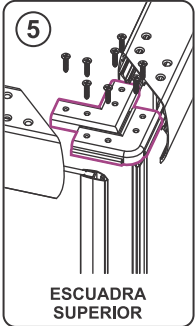
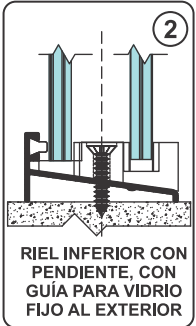
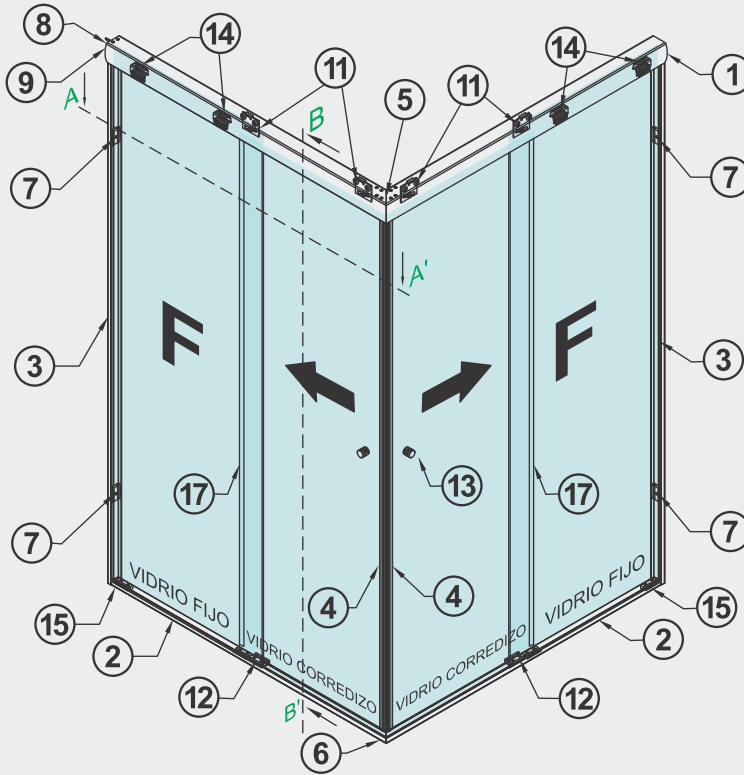

## CORTE LATERAL B-B'

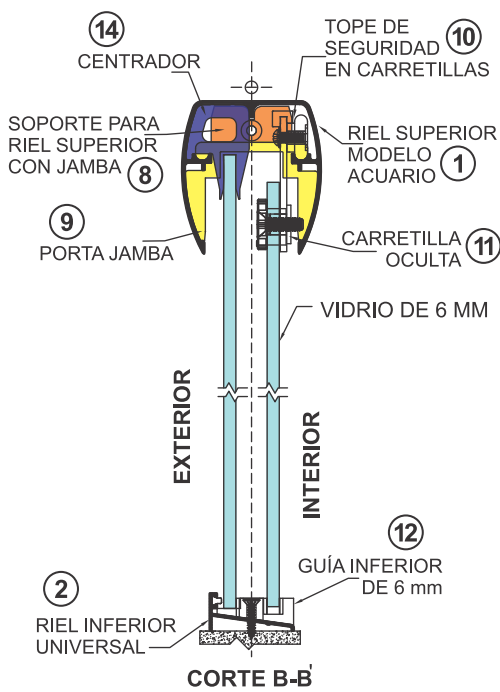

## CORTE SUPERIOR A-A'

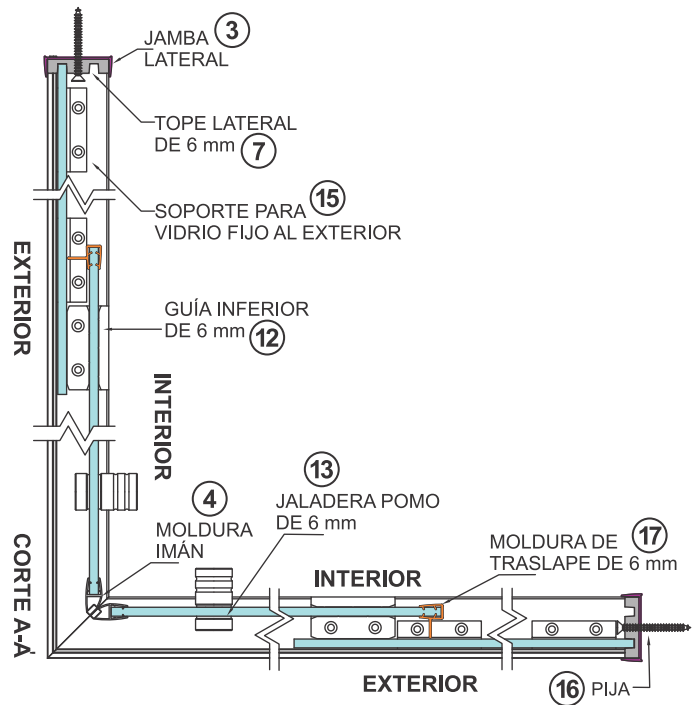

# Corte y Alzado Cancel en Escuadra Fijo Interior/Corredizo-Corredizo/Fijo Interior

- ①  RIEL SUPERIOR
- ②  RIEL INFERIOR
- ③  JAMBA LATERAL
- ④  MOLDURA IMÁN
- ⑤  ESCUADRA SUPERIOR
- ⑥  ESCUADRA INFERIOR
- ⑦  TOPE LATERAL
- ⑧  SOPORTE PARA RIEL SUPERIOR CON JAMBA
- ⑨  PORTA JAMBA
- ⑩  TOPE DE SEGURIDAD
- ⑪  CARRETILLA OCULTA
- ⑫  GUÍA INFERIOR DE 6 mm
- ⑬  JALADERA POMO DE 6 mm
- ⑭  CENTRADOR
- ⑮  PIJAS Y TAQUETES
- ⑯  MOLDURA DE TRASLAPE DE 6 mm

Compatible con:

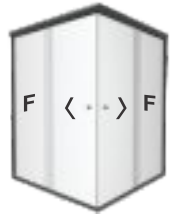
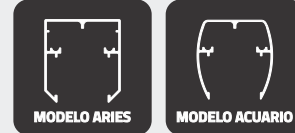

Cancel en Escuadra Fijo Interior/Corredizo-Corredizo/Fijo Interior

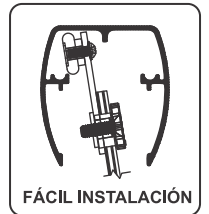
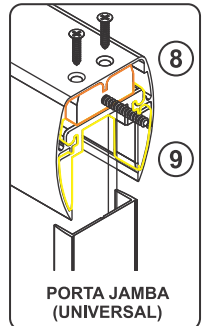
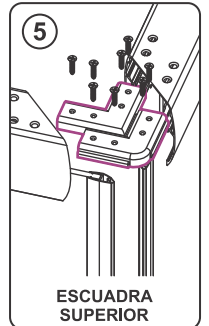
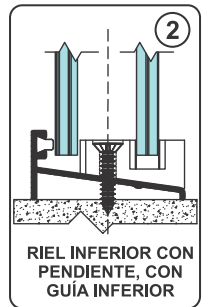
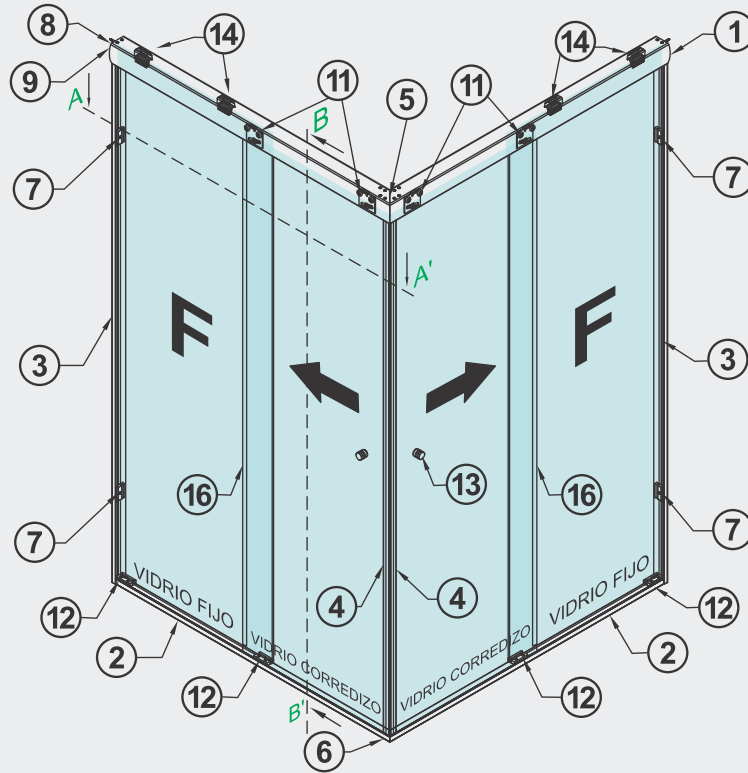

## CORTE SUPERIOR A-A'

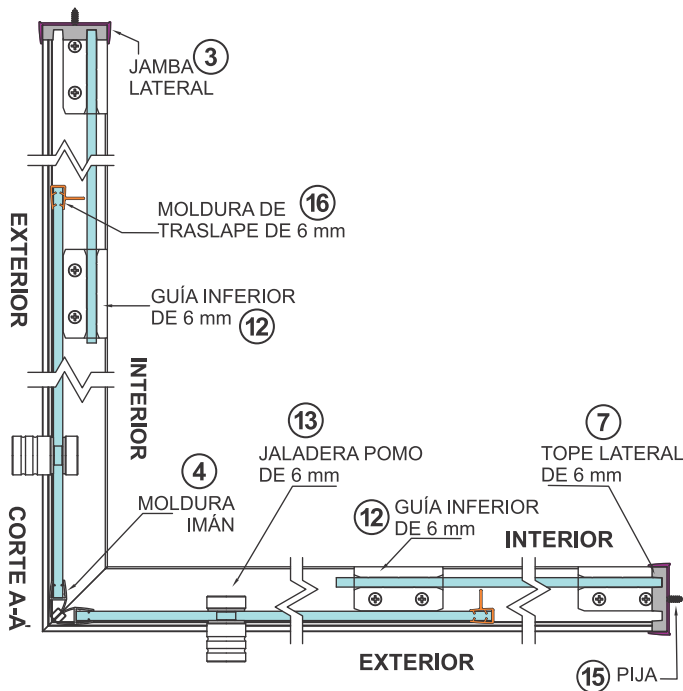

## CORTE LATERAL B-B'

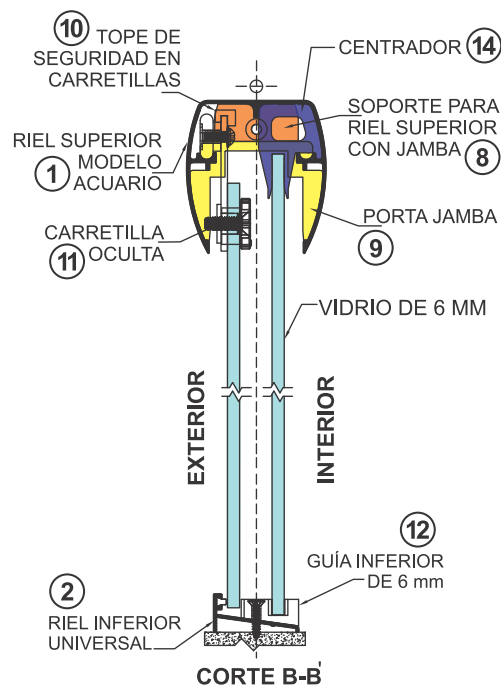



# Corte y Alzado Cancel en Escuadra Fijo Exterior-Corredizo/Fijo Interior



Cancel en Escuadra Fijo Exterior-Corredizo Fijo Interior

Compatible con:

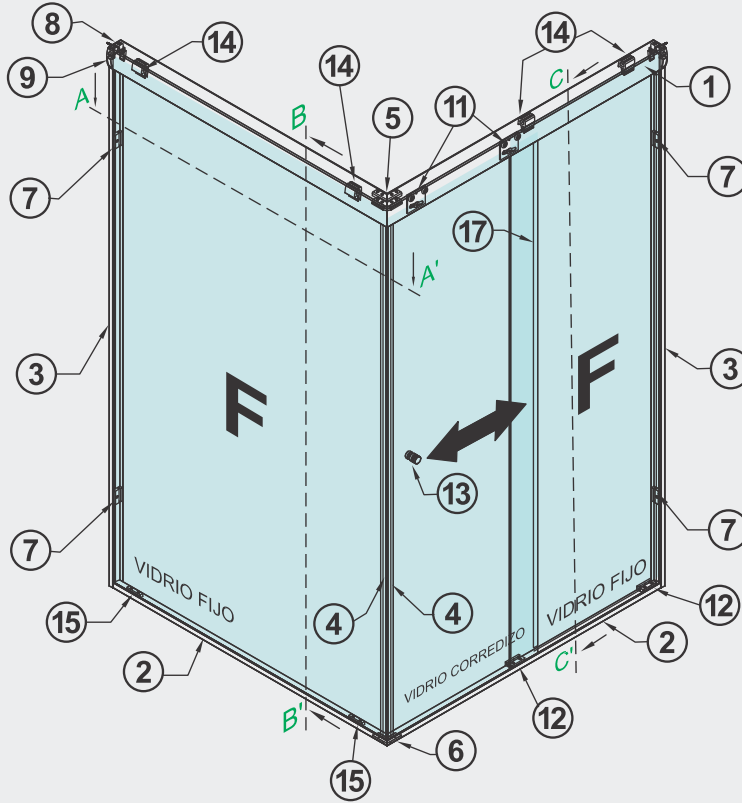
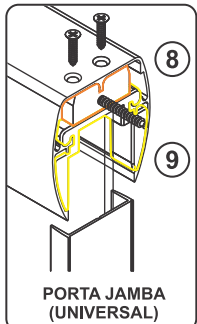
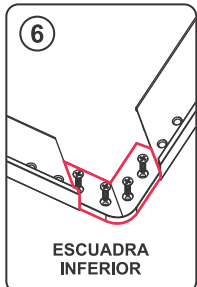
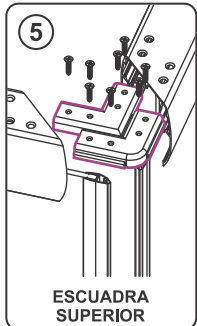
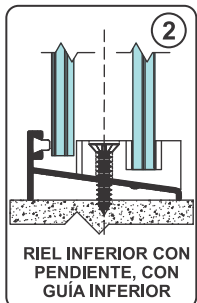
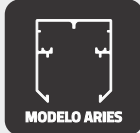

- ① RIEL SUPERIOR
- ② RIEL INFERIOR
- ③ JAMBA LATERAL
- ④ MOLDURA IMÁN
- ⑤ ESCUADRA SUPERIOR
- ⑥ ESCUADRA INFERIOR
- ⑦ TOPE LATERAL
- ⑧ SOPORTE PARA RIEL SUPERIOR CON JAMBA
- ⑨ PORTA JAMBA
- ⑩ TOPE DE SEGURIDAD
- ⑪ CARRETILLA OCULTA
- ⑫ GUÍA INFERIOR DE 6 mm
- ⑬ JALADERA POMO DE 6 mm
- ⑭ CENTRADOR
- ⑮ SOPORTE PARA VIDRIO FIJO AL EXTERIOR
- ⑯ PIJAS Y TAQUETES
- ⑰ MOLDURA DE TRASLAPE DE 6 mm

## CORTE LATERAL C-C'

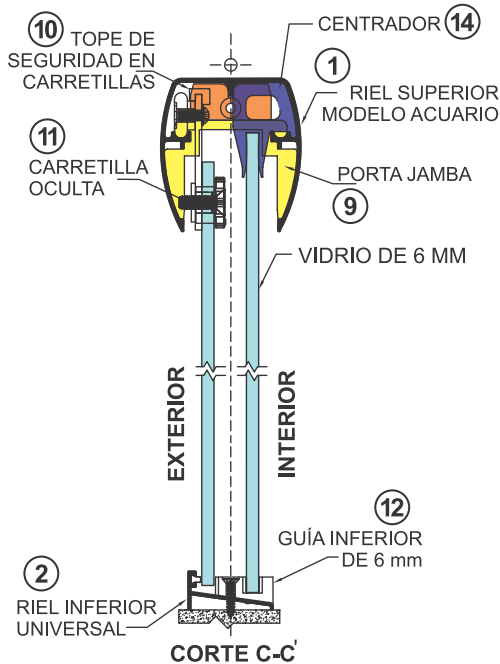

## CORTE SUPERIOR A-A'

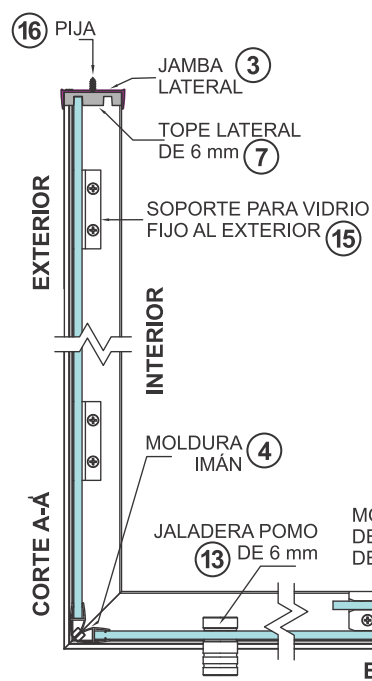

## CORTE LATERAL B-B'

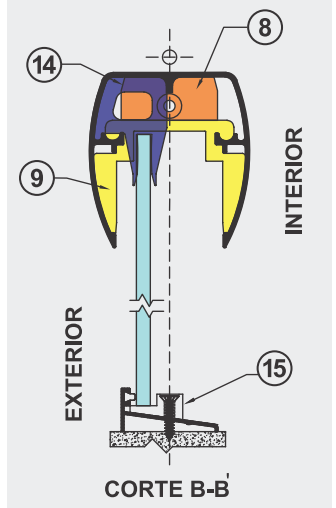

# Corte y Alzado Cancel Recto Corredizo/Corredizo



Cancel Recto  
Corredizo/Corredizo



RIEL OPCIONAL DE ALUMINIO

- |   |  |                   |   |  |                                      |
|---|--|-------------------|---|--|--------------------------------------|
| ① |  | RIEL SUPERIOR     | ⑥ |  | SOPORTE PARA RIEL SUPERIOR SIN JAMBA |
| ② |  | RIEL INFERIOR ◆   | ⑦ |  | GUÍA INFERIOR DE 6 mm                |
| ③ |  | TOPE DE SEGURIDAD | ⑧ |  | JALADERA POMO DE 6 mm                |
| ④ |  | CARRETILLA OCULTA | ⑨ |  | PIJAS Y TAQUETES                     |
| ⑤ |  | MOLDURA BURBUJA   | ⑩ |  | MOLDURA DE TRASLAPE DE 6 mm          |

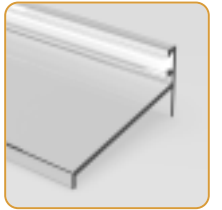

Compatible con:

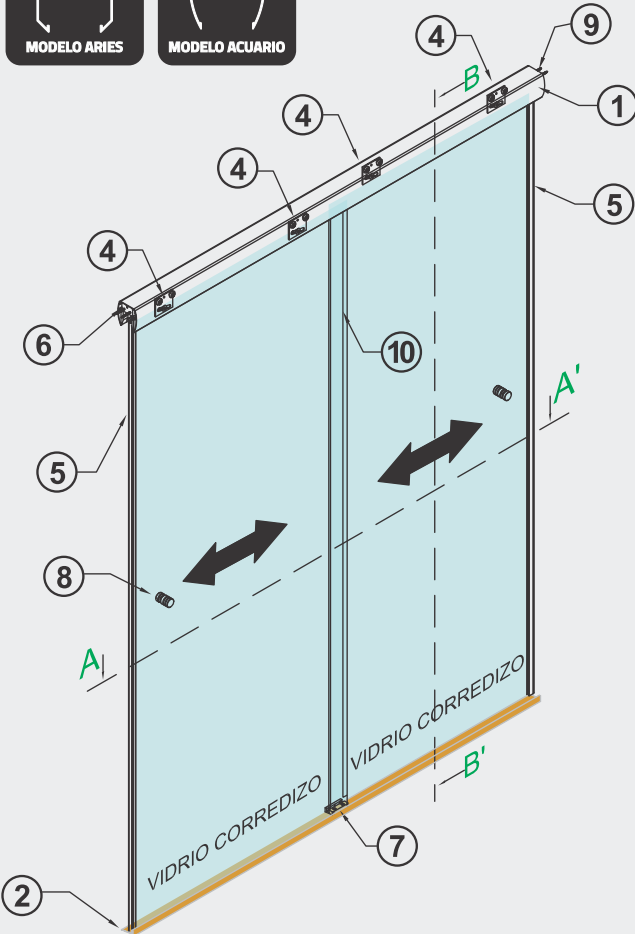

## CORTE LATERAL B-B'

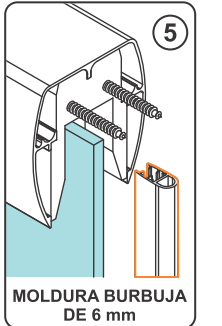
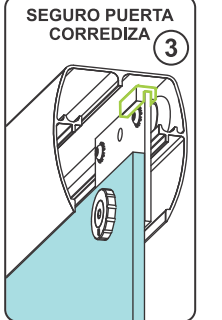
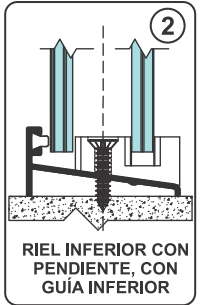
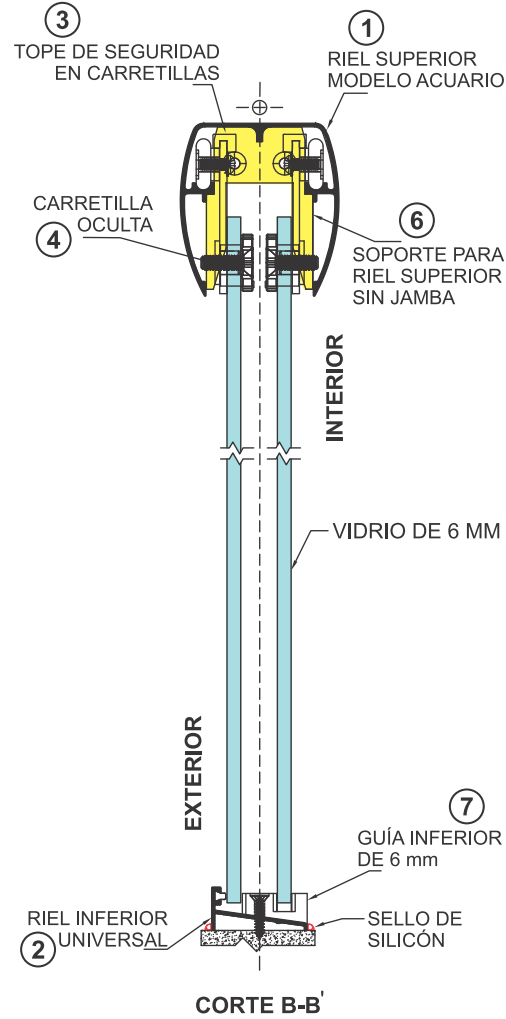

## CORTE SUPERIOR A-A'

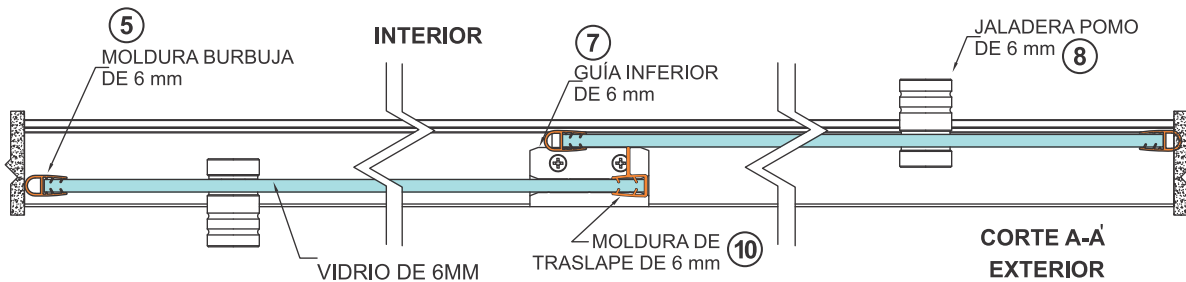



# Corte y Alzado Cancel Recto Corredizo/Fijo Interior



- ① RIEL SUPERIOR
- ② RIEL INFERIOR ◆
- ③ MOLDURA BURBUJA
- ④ TOPE DE SEGURIDAD
- ⑤ CARRETILLA OCULTA
- ⑥ GUÍA INFERIOR DE 6 mm
- ⑦ CENTRADOR
- ⑧ JALADERA POMO DE 6 mm
- ⑨ SOPORTE PARA RIEL SUPERIOR SIN JAMBA
- ⑩ PIJAS Y TAQUETES
- ⑪ MOLDURA DE TRASLAPE DE 6 mm



Cancel Recto Corredizo/Fijo Interior

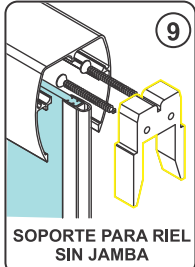
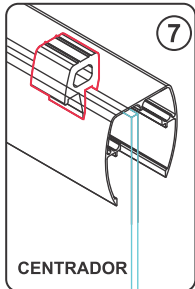
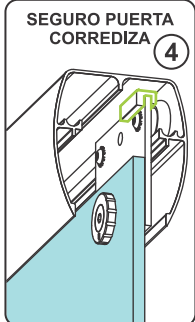
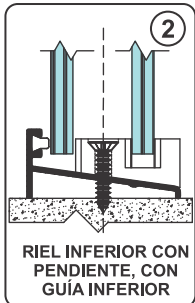

## CORTE LATERAL B-B'

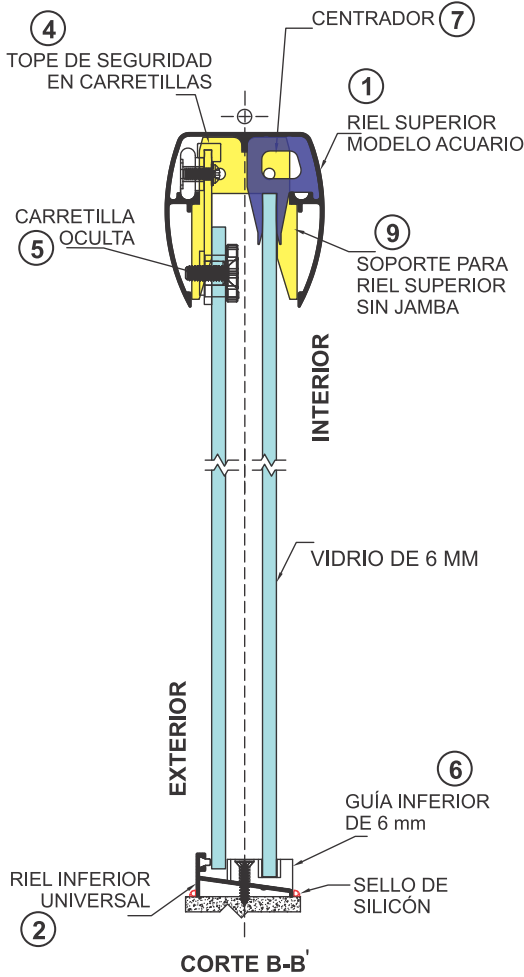

## Compatible con:

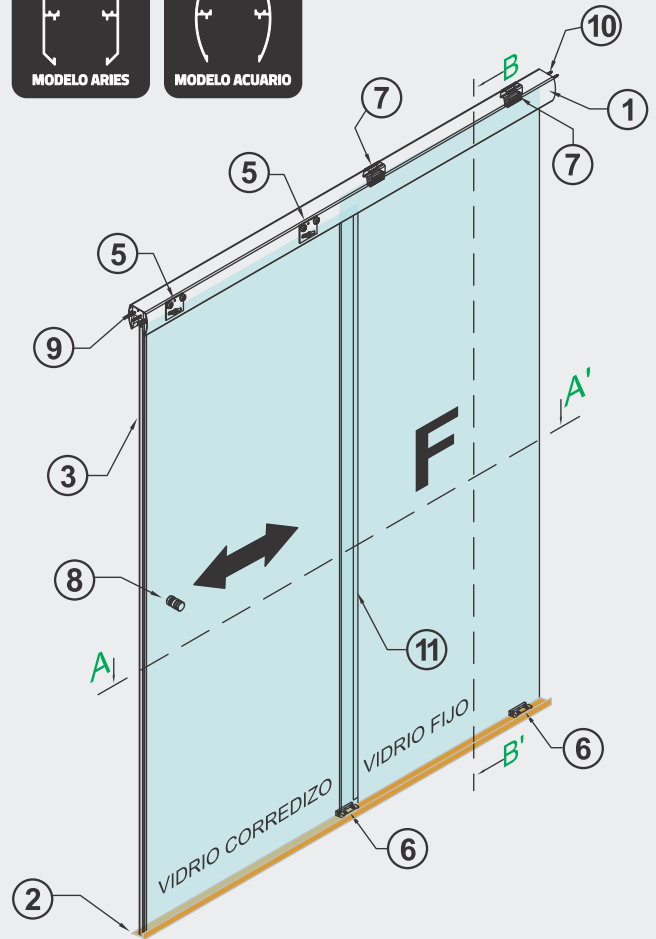
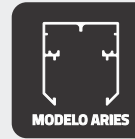

## CORTE SUPERIOR A-A'

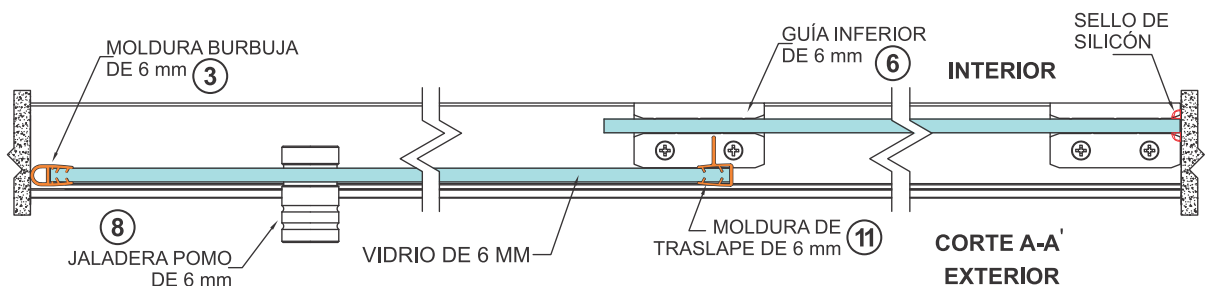

# Corte y Alzado Cancel Recto Fijo Exterior/Corredizo



Cancel Recto Fijo Exterior/Corredizo



- |                          |   |
|--------------------------|---|
| ①  RIEL SUPERIOR         | ⑦  CENTRADOR                            |
| ②  RIEL INFERIOR         | ⑧  JALADERA POMO DE 6 mm                |
| ③  MOLDURA BURBUJA       | ⑨  SOPORTE PARA RIEL SUPERIOR SIN JAMBA |
| ④  TOPE DE SEGURIDAD     | ⑩  SOPORTE PARA VIDRIO FIJO AL EXT.     |
| ⑤  CARRETILLA OCULTA     | ⑪  PIJAS Y TAQUETES                     |
| ⑥  GUÍA INFERIOR DE 6 mm | ⑫  MOLDURA DE TRASLAPE DE 6 mm          |

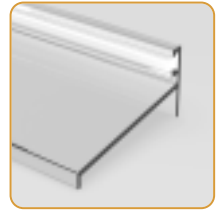

Compatible con:

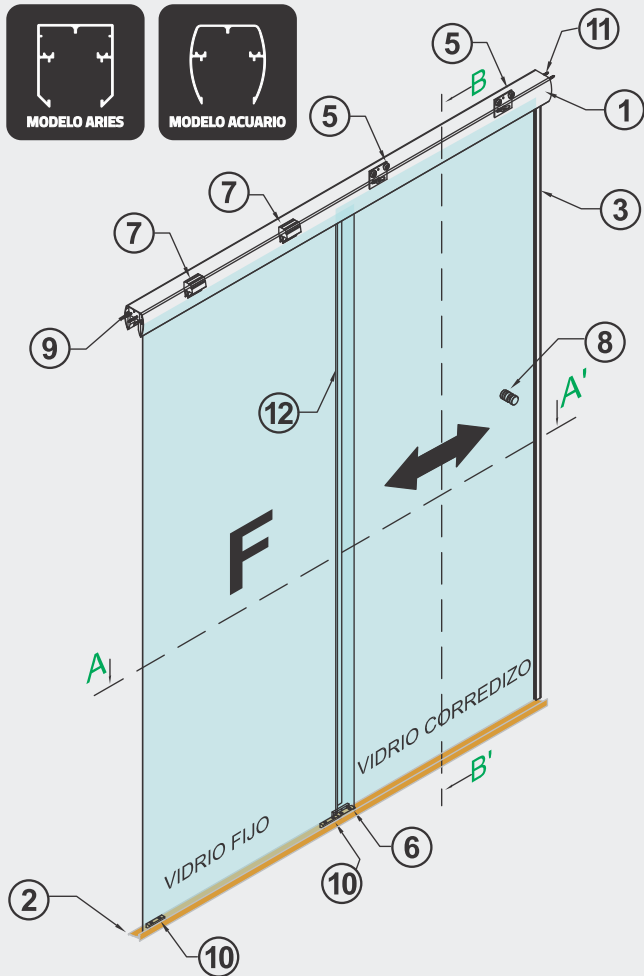
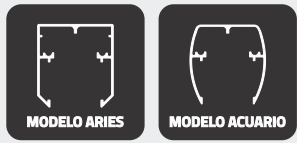

## CORTE LATERAL B-B'

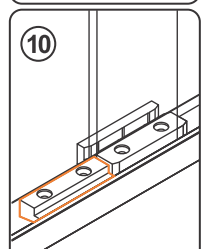
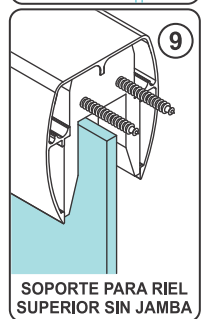
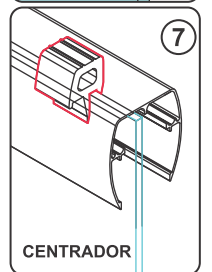
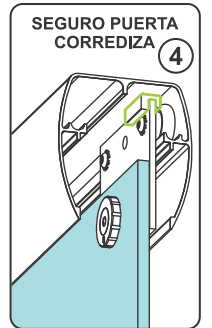
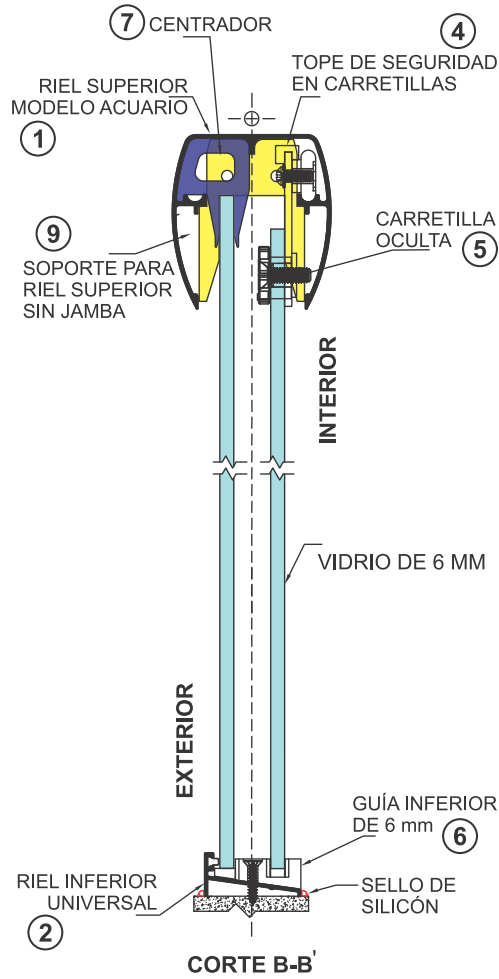

## CORTE SUPERIOR A-A'

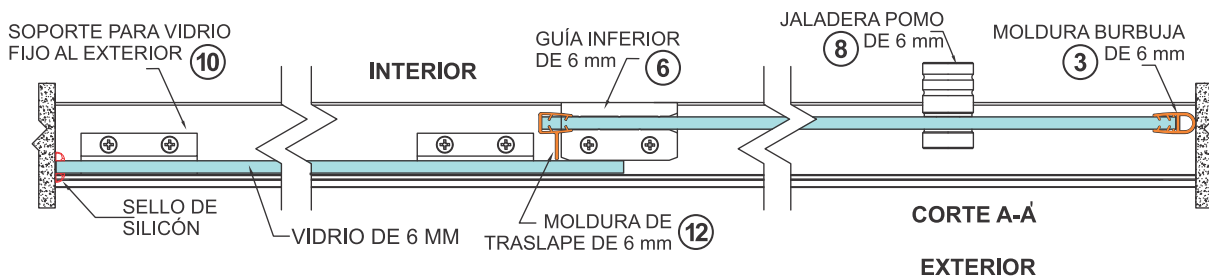



Corte y Alzado Cancel en Escuadra Fijo Exterior/Corredizo-Corredizo/Fijo Exterior



Compatible con:

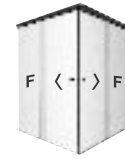
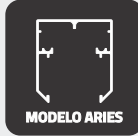

Cancel en Escuadra Fijo Exterior/Corredizo-Corredizo/Fijo Exterior

- 1 RIEL SUPERIOR
- 2 RIEL INFERIOR ◆
- 3 MOLDURA IMÁN
- 4 ESCUADRA SUPERIOR
- 5 ESCUADRA INFERIOR
- 6 SOPORTE PARA RIEL SUPERIOR SIN JAMBA
- 7 TOPE DE SEGURIDAD
- 8 CARRETILLA OCULTA
- 9 GUÍA INFERIOR DE 6 mm
- 10 JALADERA POMO DE 6 mm
- 11 CENTRADOR
- 12 SOPORTE PARA VIDRIO FIJO AL EXTERIOR
- 13 PIJAS Y TAQUETES
- 14 MOLDURA DE TRASLAPE DE 6 mm
- 15 MOLDURA BURBUJA

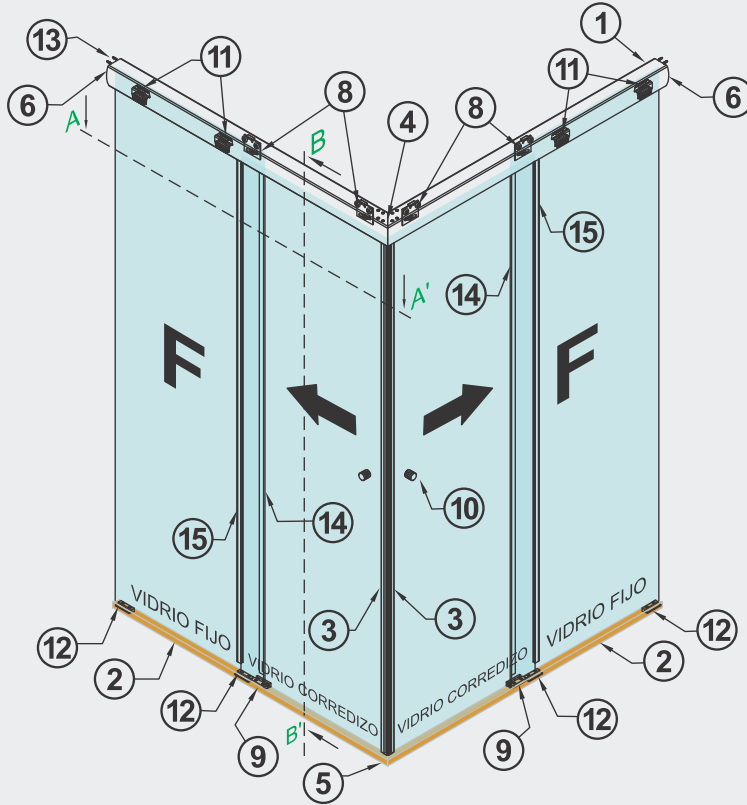
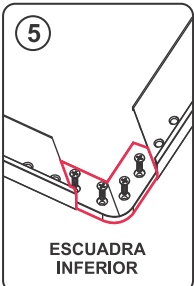
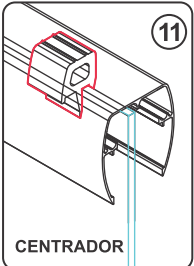
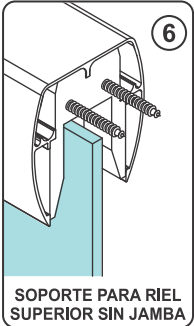
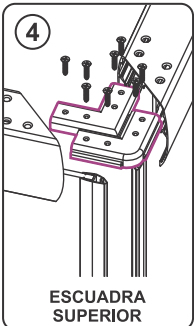

CORTE LATERAL B-B'

CORTE SUPERIOR A-A'

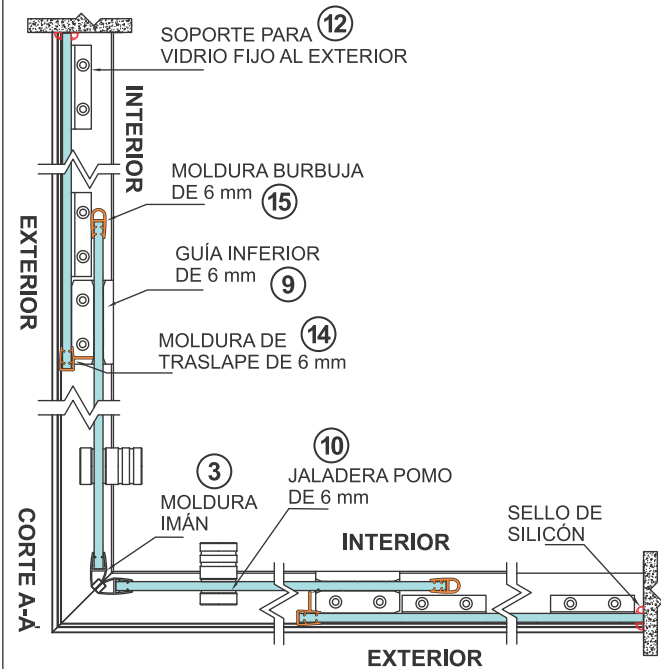
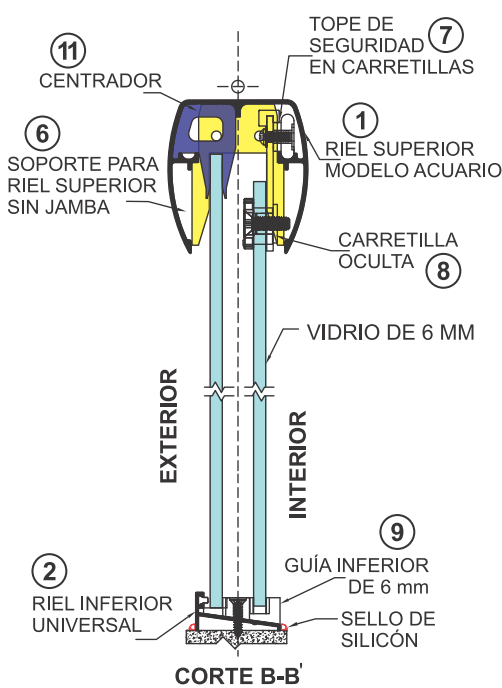

# Corte y Alzado Cancel en Escuadra Fijo Interior/Corredizo-Corredizo/Fijo Interior

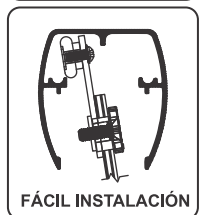
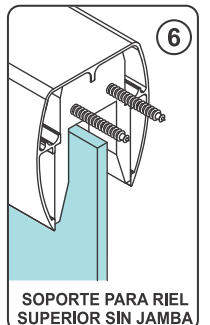
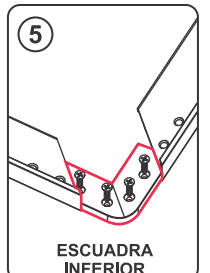
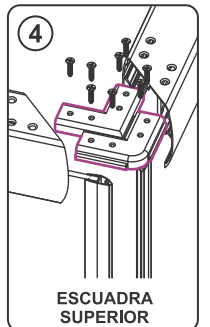
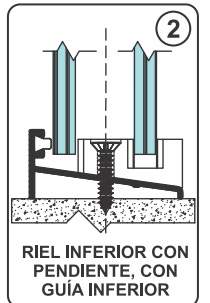

Cancel en Escuadra Fijo Interior/Corredizo-Corredizo/Fijo Interior



Compatible con:

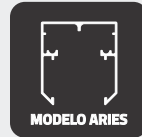

- ① RIEL SUPERIOR
- ② RIEL INFERIOR ◆
- ③ MOLDURA IMÁN
- ④ ESCUADRA SUPERIOR
- ⑤ ESCUADRA INFERIOR
- ⑥ SOPORTE PARA RIEL SUPERIOR SIN JAMBA
- ⑦ TOPE DE SEGURIDAD
- ⑧ CARRETILLA OCULTA
- ⑨ GUÍA INFERIOR DE 6 mm
- ⑩ JALADERA POMO DE 6 mm
- ⑪ CENTRADOR
- ⑫ PIJAS Y TAQUETES
- ⑬ MOLDURA DE TRASLAPE DE 6 mm
- ⑭ MOLDURA BURBUJA

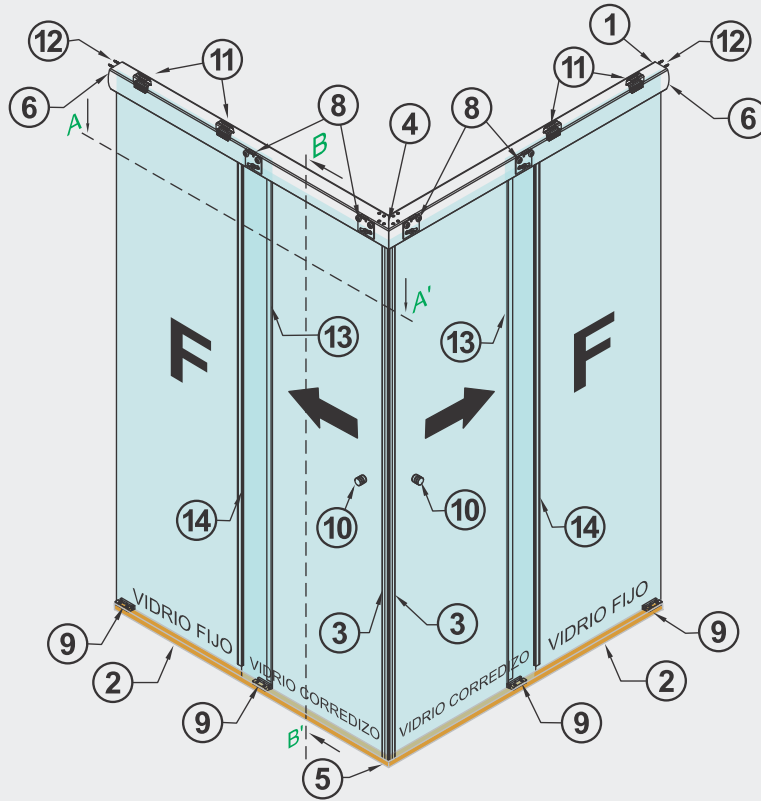

## CORTE SUPERIOR A-A'

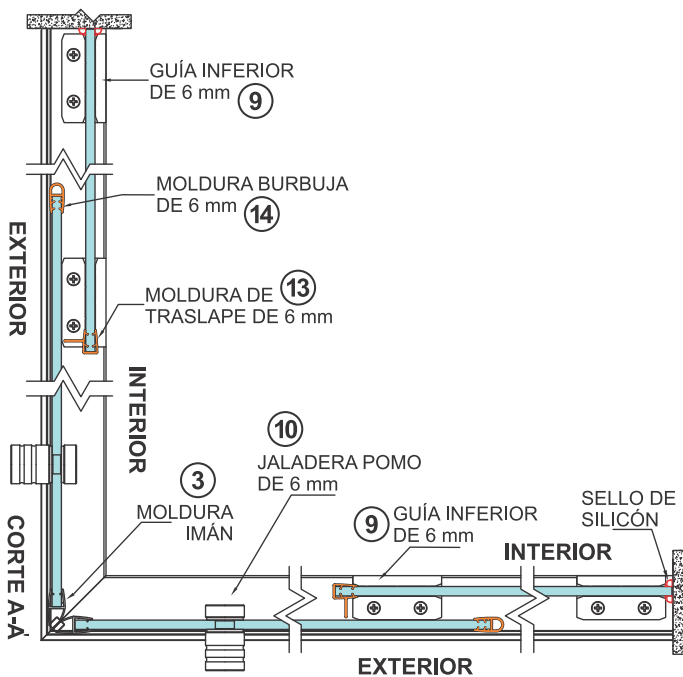

## CORTE LATERAL B-B'

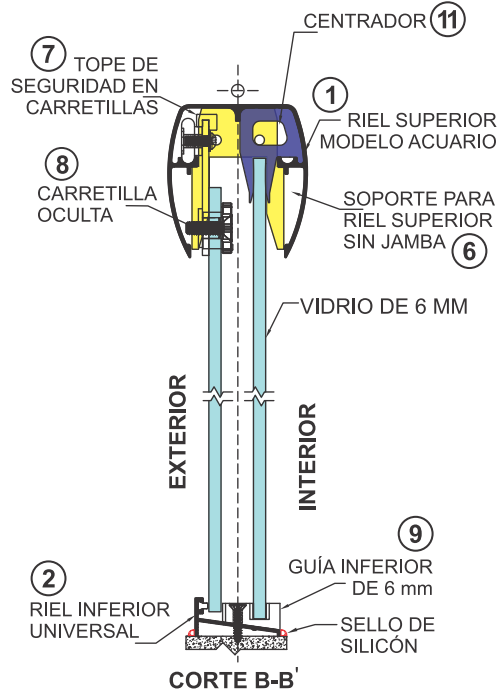

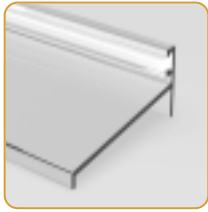

## Corte y Alzado Cancel en Escuadra Fijo Exterior-Corredizo/Fijo Interior



Compatible con:

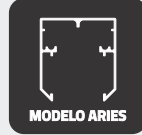

Cancel en Escuadra Fijo Exterior-Corredizo/Fijo Interior

- 1 RIEL SUPERIOR
- 2 RIEL INFERIOR
- 3 MOLDURA IMÁN
- 4 ESCUADRA SUPERIOR
- 5 ESCUADRA INFERIOR
- 6 SOPORTE PARA RIEL SUPERIOR SIN JAMBA
- 7 TOPE DE SEGURIDAD
- 8 CARRETILLA OCULTA
- 9 GUÍA INFERIOR DE 6 mm
- 10 JALADERA POMO DE 6 mm
- 11 CENTRADOR
- 12 SOPORTE PARA VIDRIO FIJO AL EXTERIOR
- 13 PIJAS Y TAQUETES
- 14 MOLDURA DE TRASLAPE DE 6 mm
- 15 MOLDURA BURBUJA

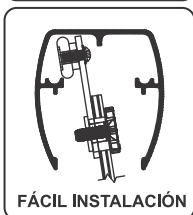
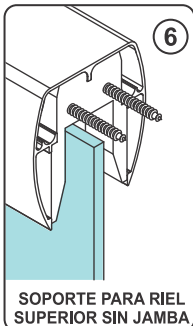
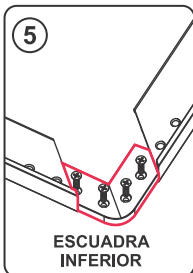
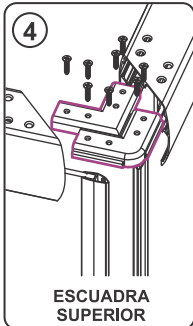
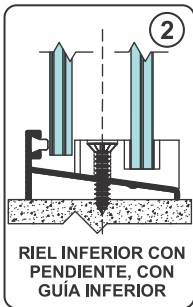
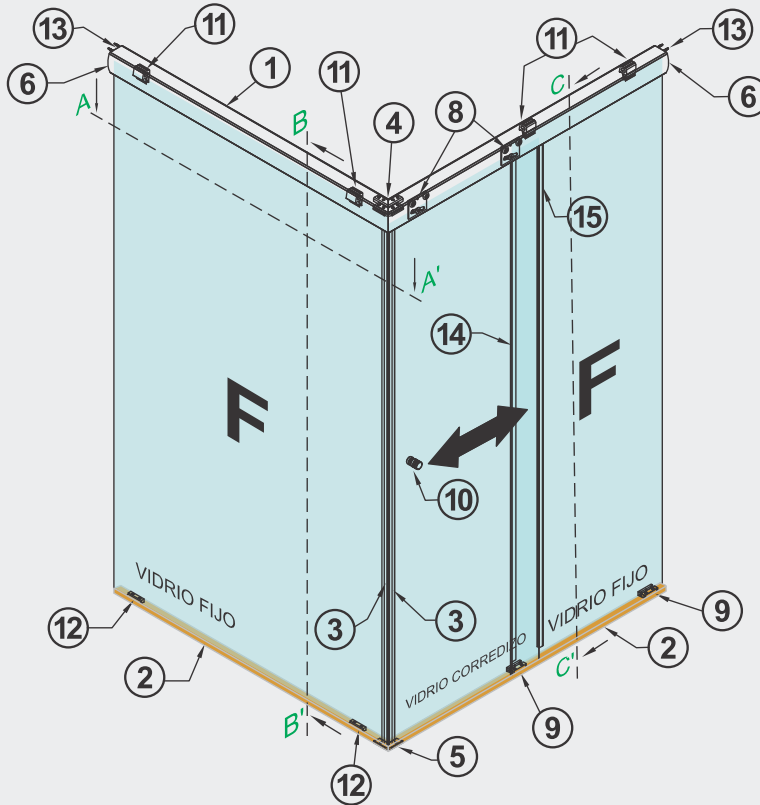

### CORTE LATERAL C-C'

### CORTE SUPERIOR A-A'

### CORTE LATERAL B-B'

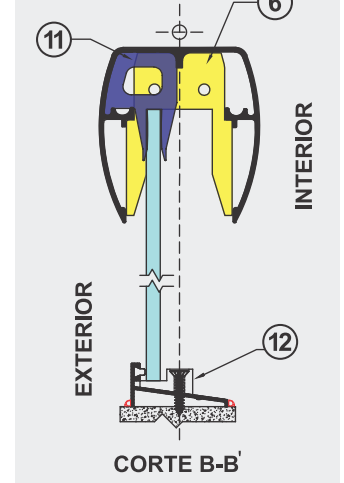
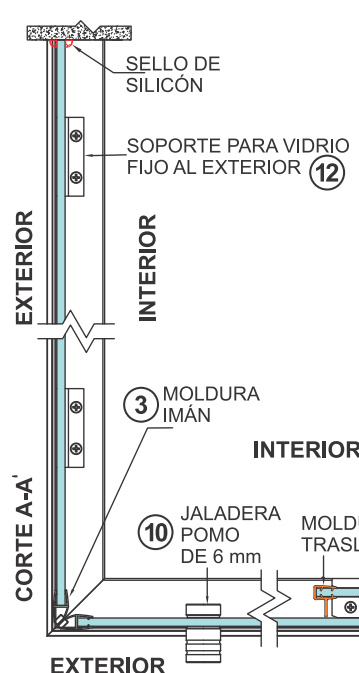
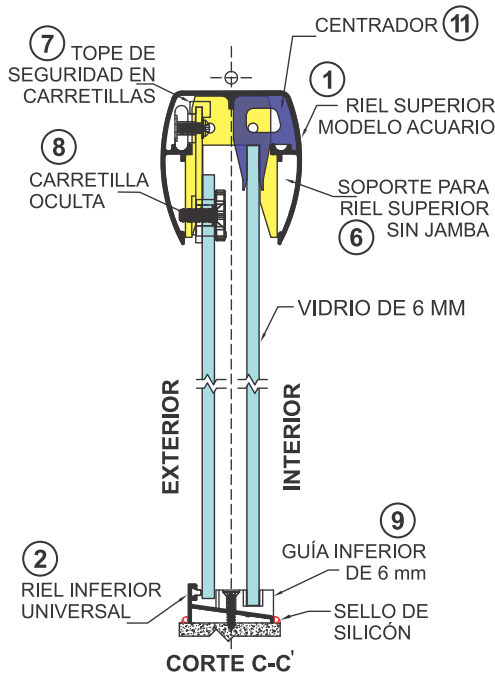

## Sistema Corredizo con Perfilera Perimetral

## Sistema Corredizo Línea Diamante



Cancel Recto  
Corredizo/Corredizo



Cancel Recto  
Corredizo/Corredizo



	<b>Riel Superior</b> PRS-ACU PRS-ARI	1 Pza		<b>Riel Superior</b> PRS-ACU PRS-ARI	1 Pza	
	<b>Jamba Lateral</b> PJL-LIG	2 Pzas		<b>Riel Inferior Transparente</b> PRI-TRNSP	1 Pza	
	<b>Riel Inferior</b> PRI-LIG	1 Pza		<b>Riel Inferior</b> ♦ PRI-LIG	1 Pza	
<b>Opcional</b>	<b>Nuevo</b>	<b>Carretilla Expuesta 1R</b>	4 Pzas	<b>Nuevo</b>	<b>Carretilla Expuesta 1R</b>	4 Pzas
		<b>Carretilla Expuesta</b> CARREX06	4 Pzas		<b>Carretilla Expuesta</b> CARREX06	4 Pzas
		<b>Carretilla Oculta</b> CARROC06	4 Pzas		<b>Carretilla Oculta</b> CARROC06	4 Pzas
	<b>Nuevo</b>	<b>Carretilla A presión 1R</b> CARR OCPR1R 6MM <small>Producto Patentado</small>	4 Pzas	<b>Nuevo</b>	<b>Carretilla A presión 1R</b> CARR OCPR1R 6MM <small>Producto Patentado</small>	4 Pzas
		<b>Carretilla A presión 2R</b> CARR OC PR 6MM <small>Producto Patentado</small>	4 Pzas		<b>Carretilla A presión 2R</b> CARR OC PR 6MM <small>Producto Patentado</small>	4 Pzas
	<b>Tope de Seguridad</b> TOPE SEG CARR	4 Pzas		<b>Tope de Seguridad</b> TOPE SEG CARR	4 Pzas	
	<b>Pijas y taquetes</b>	4 Jgos		<b>Pijas y taquetes</b>	4 Jgos	
	<b>Porta Jamba</b> PRT-RIEL	2 Pzas		<b>Soporte para Riel sin Jamba</b> SOP PRS SJL	2 Pzas	
	<b>Jaladera Pomo</b> JALPOMO 6MM	2 Jgos		<b>Jaladera Pomo</b> JALPOMO 6MM	2 Jgos	
	<b>Tope Lateral</b> JGO TOPETR 6	4 Pzas		<b>Moldura Burbuja</b> BURB 6MM	3 Pzas	
	<b>Guía Inferior</b> GUIA PLS 6MM	1 Pza		<b>Guía Inferior</b> GUIA PLS 6MM	1 Pza	
	<b>Moldura de Traslape</b> SELLHEMET 6MM <small>Incluido en Promoción</small>	1 Pza		<b>Moldura de Traslape</b> SELLHEMET 6MM <small>Incluido en Promoción</small>	1 Pza	



## Sistema Corredizo con Perfilera Perimetral

## Sistema Corredizo Línea Diamante



Cancel Recto  
Fijo Exterior/Corredizo



Cancel Recto  
Fijo Exterior/Corredizo



	<b>Riel Superior</b> PRS-ACU PRS-ARI	1 Pza		<b>Riel Superior</b> PRS-ACU PRS-ARI	1 Pza	
	<b>Jamba Lateral</b> PJL-LIG	2 Pzas		<b>Riel Inferior Transparente</b> PRI-TRNSP	1 Pza	
	<b>Riel Inferior</b> PRI-LIG	1 Pza		<b>Riel Inferior</b> ♦ PRI-LIG	1 Pza	
Opcional	<b>Nuevo</b>	<b>Carretilla Expuesta 1R</b>	2 Pzas	<b>Nuevo</b>	<b>Carretilla Expuesta 1R</b>	2 Pzas
		<b>Carretilla Expuesta</b> CARREX06	2 Pzas		<b>Carretilla Expuesta</b> CARREX06	2 Pzas
		<b>Carretilla Oculta</b> CARROC06	2 Pzas		<b>Carretilla Oculta</b> CARROC06	2 Pzas
	<b>Nuevo</b>	<b>Carretilla A presión 1R</b> CARR OCPR1R 6MM <small>Producto Patentado</small>	2 Pzas	<b>Nuevo</b>	<b>Carretilla A presión 1R</b> CARR OCPR1R 6MM <small>Producto Patentado</small>	2 Pzas
		<b>Carretilla A presión 2R</b> CARR OC PR 6MM <small>Producto Patentado</small>	2 Pzas	<b>Nuevo</b>	<b>Carretilla A presión 2R</b> CARR OC PR 6MM <small>Producto Patentado</small>	2 Pzas
		<b>Tope de Seguridad</b> TOPE SEG CARR	2 Pzas		<b>Tope de Seguridad</b> TOPE SEG CARR	2 Pzas
		<b>Pijas y taquetes</b>	4 Jgos		<b>Pijas y taquetes</b>	4 Jgos
		<b>Porta Jamba</b> PRT-RIEL	2 Pzas		<b>Soporte para Riel sin Jamba</b> SOP PRS SJL	2 Pzas
		<b>Jaladera Pomo</b> JALPOMO 6MM	1 Jgo		<b>Jaladera Pomo</b> JALPOMO 6MM	1 Jgo
		<b>Tope Lateral</b> JGO TOPETR 6	4 Pzas		<b>Moldura Burbuja</b> BURB 6MM	1 Pza
		<b>Guía Inferior</b> GUIA PLS 6MM	1 Pza		<b>Guía Inferior</b> GUIA PLS 6MM	1 Pza
		<b>Centrador</b> CENT 6MM	2 Pzas		<b>Centrador</b> CENT 6MM	2 Pzas
	<b>Soporte para Vidrio Fijo al Exterior</b> SOPFIJOEXT 6MM	2 Pzas		<b>Soporte para Vidrio Fijo al Exterior</b> SOPFIJOEXT 6MM	2 Pzas	
	<b>Moldura de Traslape</b> SELLHEMET 6MM <small>Incluido en Promoción</small>	1 Pza		<b>Moldura de Traslape</b> SELLHEMET 6MM <small>Incluido en Promoción</small>	1 Pza	

## Sistema Corredizo con Perfilera Perimetral

## Sistema Corredizo Línea Diamante



Cancel Recto  
Corredizo/Fijo Interior



Cancel Recto  
Corredizo/Fijo Interior

	<b>Riel Superior</b> PRS-ACU PRS-ARI	1 Pza		<b>Riel Superior</b> PRS-ACU PRS-ARI	1 Pza	
	<b>Jamba Lateral</b> PJL-LIG	2 Pzas		<b>Riel Inferior Transparente</b> PRI-TRNSP	1 Pza	
	<b>Riel Inferior</b> PRI-LIG	1 Pza		<b>Riel Inferior</b> ♦ PRI-LIG	1 Pza	
<b>Opcional</b>	<b>Nuevo</b>	<b>Carretilla Expuesta 1R</b>	2 Pzas	<b>Nuevo</b>	<b>Carretilla Expuesta 1R</b>	2 Pzas
		<b>Carretilla Expuesta</b> CARREX06	2 Pzas		<b>Carretilla Expuesta</b> CARREX06	2 Pzas
		<b>Carretilla Oculta</b> CARROC06	2 Pzas		<b>Carretilla Oculta</b> CARROC06	2 Pzas
	<b>Nuevo</b>	<b>Carretilla A presión 1R</b> CARR OCP1R 6MM <small>Producto Patentado</small>	2 Pzas	<b>Nuevo</b>	<b>Carretilla A presión 1R</b> CARR OCP1R 6MM <small>Producto Patentado</small>	2 Pzas
	<b>Nuevo</b>	<b>Carretilla A presión 2R</b> CARR OC PR 6MM <small>Producto Patentado</small>	2 Pzas	<b>Nuevo</b>	<b>Carretilla A presión 2R</b> CARR OC PR 6MM <small>Producto Patentado</small>	2 Pzas
	<b>Tope de Seguridad</b> TOPE SEG CARR	2 Pzas		<b>Tope de Seguridad</b> TOPE SEG CARR	2 Pzas	
	<b>Pijas y taquetes</b>	4 Jgos		<b>Pijas y taquetes</b>	4 Jgos	
	<b>Porta Jamba</b> PRT-RIEL	2 Pzas		<b>Soporte para Riel sin Jamba</b> SOP PRS SJL	2 Pzas	
	<b>Jaladera Pomo</b> JALPOMO 6MM	1 Jgo		<b>Jaladera Pomo</b> JALPOMO 6MM	1 Jgo	
	<b>Tope Lateral</b> JGO TOPETR 6	4 Pzas		<b>Moldura Burbuja</b> BURB 6MM	1 Pza	
	<b>Guía Inferior</b> GUIA PLS 6MM	1 Pza		<b>Guía Inferior</b> GUIA PLS 6MM	1 Pza	
	<b>Centrador</b> CENT 6MM	2 Pzas		<b>Centrador</b> CENT 6MM	2 Pzas	
	<b>Guía para Vidrio Fijo al Interior</b> GUIA PLS 6MM	1 Pza		<b>Guía para Vidrio Fijo al Interior</b> GUIA PLS 6MM	1 Pza	
	<b>Moldura de Traslape</b> SELLHEMET 6MM <small>Incluido en Promoción</small>	1 Pza		<b>Moldura de Traslape</b> SELLHEMET 6MM <small>Incluido en Promoción</small>	1 Pza	

## Sistema Corredizo con Perfilera Perimetral

## Sistema Corredizo Línea Diamante



Cancel en Escuadra Fijo Exterior/Corredizo-Corredizo/Fijo Exterior



Cancel en Escuadra Fijo Exterior/Corredizo-Corredizo/Fijo Exterior

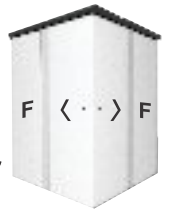

		<b>Riel Superior</b> PRS-ACU PRS-ARI	2 Pzas		<b>Riel Superior</b> PRS-ACU PRS-ARI	2 Pzas
		<b>Jamba Lateral</b> PJL-LIG	2 Pzas		<b>Riel Inferior Transparente</b> PRI-TRNSP	2 Pzas
		<b>Riel Inferior</b> PRI-LIG	2 Pzas		<b>Riel Inferior</b> ♦ PRI-LIG	2 Pzas
Opcional		<b>Carretilla Expuesta 1R</b> CARREX06	4 Pzas		<b>Carretilla Expuesta 1R</b> CARREX06	4 Pzas
		<b>Carretilla Oculta</b> CARROC06	4 Pzas		<b>Carretilla Oculta</b> CARROC06	4 Pzas
		<b>Carretilla A presión 1R</b> CARR OCP1R 6MM Producto Patentado	4 Pzas		<b>Carretilla A presión 1R</b> CARR OCP1R 6MM Producto Patentado	4 Pzas
		<b>Carretilla A presión 2R</b> CARR OC PR 6MM Producto Patentado	4 Pzas		<b>Carretilla A presión 2R</b> CARR OC PR 6MM Producto Patentado	4 Pzas
		<b>Tope de Seguridad</b> TOPE SEG CARR	4 Pzas		<b>Tope de Seguridad</b> TOPE SEG CARR	4 Pzas
		<b>Pijas y taquetes</b>	4 Jgos		<b>Pijas y taquetes</b>	4 Jgos
		<b>Porta Jamba</b> PRT-RIEL	2 Pzas		<b>Soporte para Riel sin Jamba</b> SOP PRS SJL	2 Pzas
		<b>Jaladera Pomo</b> JALPOMO 6MM	2 Jgos		<b>Jaladera Pomo</b> JALPOMO 6MM	2 Jgos
		<b>Tope Lateral</b> JGO TOPETR 6	4 Pzas		<b>Moldura Burbuja</b> BURB 6MM	2 Pzas
		<b>Guía Inferior</b> GUIA PLS 6MM	2 Pzas		<b>Guía Inferior</b> GUIA PLS 6MM	1 Pza
	<b>Centrador</b> CENT 6MM	4 Pzas		<b>Centrador</b> CENT 6MM	4 Pzas	
	<b>Soporte para Vidrio Fijo al Exterior</b> SOPFIJOEXT 6MM	4 Pzas		<b>Soporte para Vidrio Fijo al Exterior</b> SOPFIJOEXT 6MM	4 Pzas	
	<b>Soporte para Riel Superior con Jamba</b> SOP PRS CJL	2 Pzas		<b>Escuadra para Riel Superior</b> ESC2 PBAÑO	1 Pza	
	<b>Escuadra para Riel Superior</b> ESC2 PBAÑO	1 Pza		<b>Escuadra para Riel Inferior</b> ESC INFTR PBAÑO	1 Pza	
	<b>Escuadra para Riel Inferior</b> ESC INF PBAÑO	1 Pza		<b>Guía para Traslape</b> GUIA PLS 6MM	1 Pza	
	<b>Moldura Imán</b> PP MAGN90 6MM Se vende por Separado	2 Pzas		<b>Moldura Imán</b> PP MAGN90 6MM Se vende por Separado	2 Pzas	
	<b>Moldura de Traslape</b> SELLHEMET 6MM	2 Pzas		<b>Moldura de Traslape</b> SELLHEMET 6MM	2 Pzas	

Incluido en Promoción

Incluido en Promoción

## Sistema Corredizo con Perfilera Perimetral

## Sistema Corredizo Línea Diamante



Cancel en Escuadra Fijo Interior/Corredizo-Corredizo/Fijo Interior



Cancel en Escuadra Fijo Interior/Corredizo-Corredizo/Fijo Interior

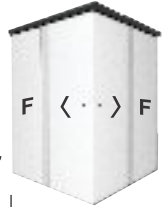

		<b>Riel Superior</b> PRS-ACU PRS-ARI	2 Pzas		<b>Riel Superior</b> PRS-ACU PRS-ARI	2 Pzas
		<b>Jamba Lateral</b> PJI-LIG	2 Pzas		<b>Riel Inferior Transparente</b> PRI-TRNSP	2 Pzas
		<b>Riel Inferior</b> PRI-LIG	2 Pzas		<b>Riel Inferior</b> ♦ PRI-LIG	2 Pzas
Opcional		<b>Carretilla Expuesta 1R</b>	4 Pzas		<b>Carretilla Expuesta 1R</b>	4 Pzas
		<b>Carretilla Expuesta</b> CARREX06	4 Pzas		<b>Carretilla Expuesta</b> CARREX06	4 Pzas
		<b>Carretilla Oculta</b> CARROC06	4 Pzas		<b>Carretilla Oculta</b> CARROC06	4 Pzas
		<b>Carretilla A presión 1R</b> CARR OCPRI1R 6MM Producto Patentado	4 Pzas		<b>Carretilla A presión 1R</b> CARR OCPRI1R 6MM Producto Patentado	4 Pzas
		<b>Carretilla A presión 2R</b> CARR OC PR 6MM Producto Patentado	4 Pzas		<b>Carretilla A presión 2R</b> CARR OC PR 6MM Producto Patentado	4 Pzas
		<b>Tope de Seguridad</b> TOPE SEG CARR	4 Pzas		<b>Tope de Seguridad</b> TOPE SEG CARR	4 Pzas
		<b>Pijas y taquetes</b>	4 Jgos		<b>Pijas y taquetes</b>	4 Jgos
		<b>Porta Jamba</b> PRT-RIEL	2 Pzas		<b>Soporte para Riel sin Jamba</b> SOP PRS SJL	2 Pzas
		<b>Jaladera Pomo</b> JALPOMO 6MM	2 Jgos		<b>Jaladera Pomo</b> JALPOMO 6MM	2 Jgos
		<b>Tope Lateral</b> JGO TOPETR 6	4 Pzas		<b>Moldura Burbuja</b> BURB 6MM	2 Pzas
	<b>Guía Inferior</b> GUIA PLS 6MM	1 Pza		<b>Guía Inferior</b> GUIA PLS 6MM	1 Pza	
	<b>Centrador</b> CENT 6MM	4 Pzas		<b>Centrador</b> CENT 6MM	4 Pzas	
	<b>Soporte para Riel Superior con Jamba</b> SOP PRS CJL	2 Pzas		<b>Escuadra para Riel Superior</b> ESC2 PBAÑO	1 Pza	
	<b>Escuadra para Riel Superior</b> ESC2 PBAÑO	1 Pza		<b>Escuadra para Riel Inferior</b> ESC INFTR PBAÑO	1 Pza	
	<b>Escuadra para Riel Inferior</b> ESC INF PBAÑO	1 Pza		<b>Guía para Vidrio Fijo al Interior</b> GUIA PLS 6MM	3 Pzas	
	<b>Guía para Vidrio Fijo al Interior</b> GUIA PLS 6MM	3 Pzas		<b>Moldura Imán</b> PP MAGN90 6MM Se vende por Separado	2 Pzas	
	<b>Moldura Imán</b> PP MAGN90 6MM Se vende por Separado	2 Pzas		<b>Moldura de Traslape</b> SELLHEMET 6MM Incluido en Promoción	2 Pzas	
	<b>Moldura de Traslape</b> SELLHEMET 6MM Incluido en Promoción	2 Pzas				

## Sistema Corredizo con Perfilera Perimetral

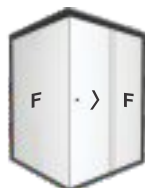

Cancel en Escuadra  
Fijo Exterior-Corredizo/  
Fijo Interior

## Sistema Corredizo Línea Diamante



Cancel en Escuadra  
Fijo Exterior-Corredizo/  
Fijo Interior

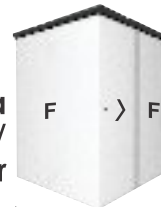

	<b>Riel Superior</b> PRS-ACU PRS-ARI	2 Pzas		<b>Riel Superior</b> PRS-ACU PRS-ARI	2 Pzas	
	<b>Jamba Lateral</b> PJL-LIG	2 Pzas		<b>Riel Inferior Transparente</b> PRI-TRNSP	2 Pzas	
	<b>Riel Inferior</b> PRI-LIG	2 Pzas		<b>Riel Inferior</b> ♦ PRI-LIG	2 Pzas	
Opcional	<b>Nuevo</b>	<b>Carretilla Expuesta 1R</b>	2 Pzas	<b>Nuevo</b>	<b>Carretilla Expuesta 1R</b>	2 Pzas
		<b>Carretilla Expuesta</b> CARREX06	2 Pzas		<b>Carretilla Expuesta</b> CARREX06	2 Pzas
		<b>Carretilla Oculta</b> CARROC06	2 Pzas		<b>Carretilla Oculta</b> CARROC06	2 Pzas
	<b>Nuevo</b>	<b>Carretilla A presión 1R</b> CARR OCP1R 6MM Producto Patentado	2 Pzas	<b>Nuevo</b>	<b>Carretilla A presión 1R</b> CARR OCP1R 6MM Producto Patentado	2 Pzas
		<b>Carretilla A presión 2R</b> CARR OC PR 6MM Producto Patentado	2 Pzas	<b>Nuevo</b>	<b>Carretilla A presión 2R</b> CARR OC PR 6MM Producto Patentado	2 Pzas
	<b>Tope de Seguridad</b> TOPE SEG CARR	2 Pzas		<b>Tope de Seguridad</b> TOPE SEG CARR	2 Pzas	
	<b>Pijas y taquetes</b>	4 Jgos		<b>Pijas y taquetes</b>	4 Jgos	
	<b>Porta Jamba</b> PRT-RIEL	2 Pzas		<b>Soporte para Riel sin Jamba</b> SOP PRS SJL	2 Pzas	
	<b>Jaladera Pomo</b> JALPOMO 6MM	1 Jgo		<b>Jaladera Pomo</b> JALPOMO 6MM	1 Jgo	
	<b>Tope Lateral</b> JGO TOPETR 6	4 Pzas		<b>Moldura Burbuja</b> BURB 6MM	1 Pza	
	<b>Guía para Vidrio Fijo al Interior</b> GUIA PLS 6MM	2 Pzas		<b>Guía para Vidrio Fijo al Interior</b> GUIA PLS 6MM	2 Pzas	
	<b>Centrador</b> CENT 6MM	4 Pzas		<b>Centrador</b> CENT 6MM	4 Pzas	
	<b>Soporte para Riel Superior con Jamba</b> SOP PRS CJL	2 Pzas		<b>Escuadra para Riel Superior</b> ESC2 PBAÑO	1 Pza	
	<b>Escuadra para Riel Superior</b> ESC2 PBAÑO	1 Pza		<b>Escuadra para Riel Inferior</b> ESC INFTR PBAÑO	1 Pza	
	<b>Escuadra para Riel Inferior</b> ESC INF PBAÑO	1 Pza		<b>Soporte para Vidrio Fijo al Exterior</b> SOPFIJOEXT 6MM	2 Pzas	
	<b>Soporte para Vidrio Fijo al Exterior</b> SOPFIJOEXT 6MM	2 Pzas		<b>Moldura Imán</b> PP MAGN90 6MM Se vende por Separado	2 Pzas	
	<b>Moldura Imán</b> PP MAGN90 6MM Se vende por Separado	2 Pzas		<b>Moldura de Traslape</b> SELLHEMET 6MM Incluido en Promoción	1 Pza	
	<b>Moldura de Traslape</b> SELLHEMET 6MM Incluido en Promoción	1 Pza				

**IntegraGlass®**

Fabricación de herrajes para vidrio

Sistemas corredizos para cristal templado



Rodamientos anticorrosivos  
para baño

La Satisfacción es  
parte de nuestra  
misión.



Sistemas corredizos para baño  
con vidrio de 6, hasta 10 mm



**RODAMIENTO ANTICORROSIVO,**  
RESPALDADO CON PRUEBA DE  
CÁMARA SALINA.



ASTM INTERNATIONAL

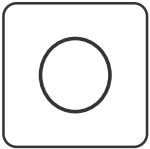

SISTEMA CON  
BARRENO



AJUSTE EN  
DESCUADRE

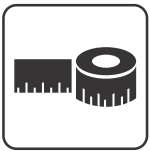

MEDIDAS  
ESPECIALES



RODAMIENTO  
ANTICORROSIVO

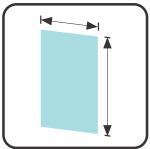

MEDIDAS  
1.20 x 2.00 Mts.  
1.50 x 2.00 Mts.  
2.00 x 2.00 Mts.

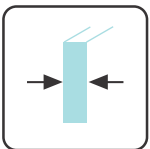

ESPEJOR  
DEL VIDRIO  
8-10 mm



ESPACIO  
ENTRE HOJAS  
5 mm



# Libra *Premium*

Sistema corredizo para baño con vidrio de 8-10 mm

# Sistema Corredizo con Perfilera Perimetral



**NOTA.**  
La instalación de nuestros sistemas corredizos con Perfilera Perimetral, exigen ser a escuadra y a nivel para una mayor eficiencia.



**MEDIDAS ESTANDAR:** 1.20 x 2.00 Mts. / 1.50 x 2.00 Mts. / 2.00 x 2.00 Mts.

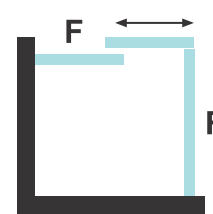
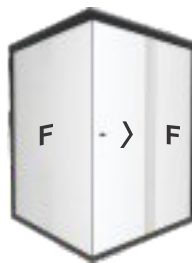
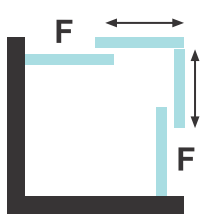

**MEDIDAS ESTANDAR:** 1.00 x 2.00 Mts. / 1.20 x 2.00 Mts.

## Medidas

**Riel Superior**

A) 86 mm

B) 69 mm

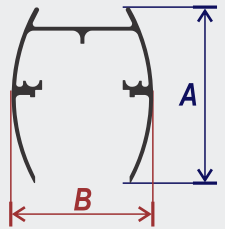

**Jamba Lateral**

A) 16 mm

B) 46 mm



**Riel Inferior**

A) 19 mm

B) 42 mm

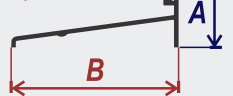

# Sistema Corredizo Línea Diamante

Línea Diamante



**MEDIDAS ESTANDAR:** 1.20 x 2.00 Mts. / 1.50 x 2.00 Mts. / 2.00 x 2.00 Mts.

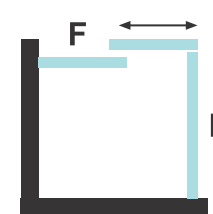
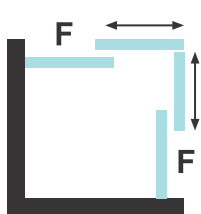

**MEDIDAS ESTANDAR:** 1.00 x 2.00 Mts. / 1.20 x 2.00 Mts.

## Medidas

**Riel Superior**

A) 86 mm

B) 69 mm

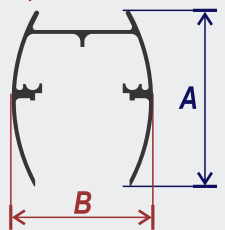

## RIEL INFERIOR TRANSPARENTE



A) 19 mm

B) 42 mm

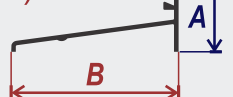

**NOTA.** La instalación de nuestros sistemas corredizos sin Jamba Lateral y en nuestra Línea Diamante, exigen ser a plomo y a escuadra para una mayor eficiencia.



## Perfilería Perimetral

## Línea Diamante

**F1**  
Distancia de la base del centrador a la base superior del Riel

**F2**  
Distancia de la base a ras de suelo a la base de asentamiento de la guía inferior.

**F3**  
Holgura entre base superior y vidrio

**F4**  
Holgura entre piso y vidrio

**Traslape de vidrio.**  
Ancho del cristal  
(Base+ 2) + ( 25mm).

**Nota:**  
El descuento para la altura de las hojas fijas, es igual a la suma de "F1" y "F2"

El descuento para la altura de las hojas corredizas, es igual a la suma de "F3" y "F4"

**DESCUENTO PARA LA ALTURA DE LA JAMBA UNIVERSAL**

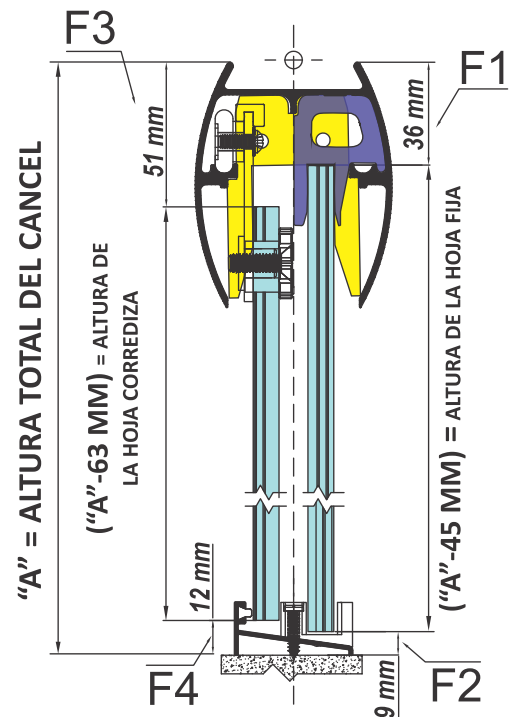
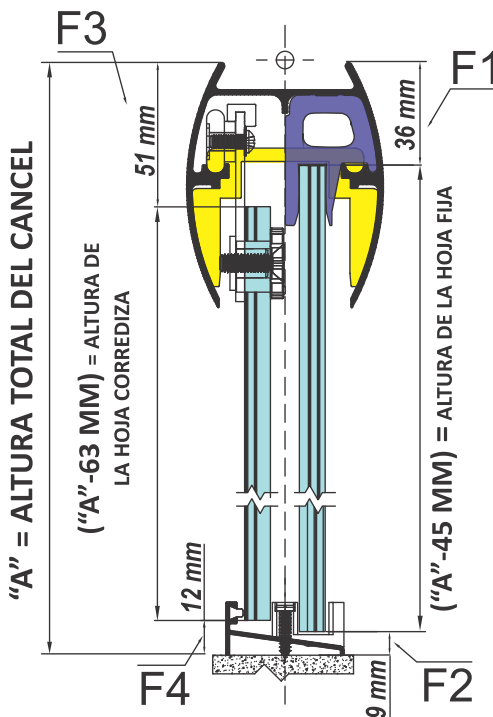
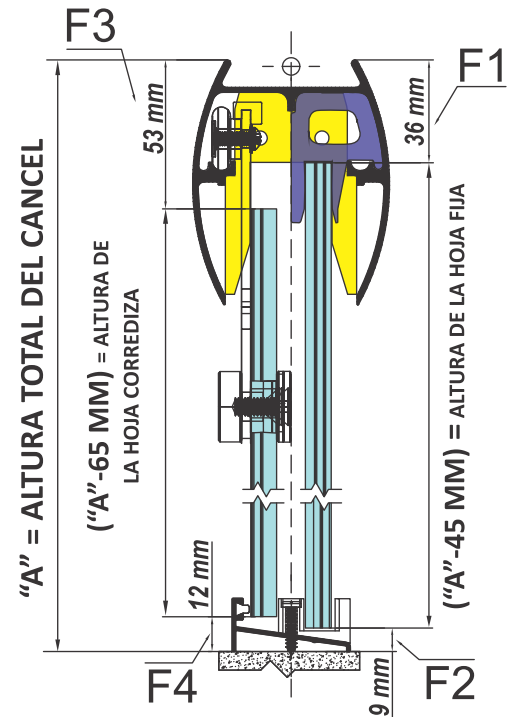
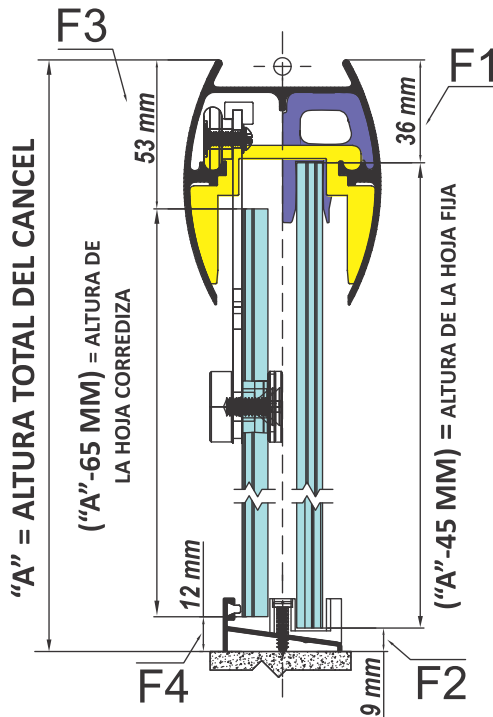
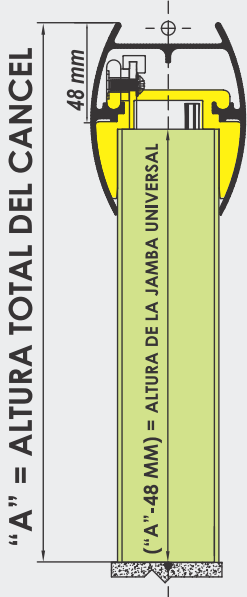

**CONFIGURACION ESCUADRA 6 MM**



**KIT DE HERRAJES**

- 1** Caretillos 5 modelos opcionales **4 Pzas**
- Expuesta 1 Rodamiento    A presión 1 Rodamiento    Expuesta    Oculta    A presión 2 Rodamientos
- 2** Jaladera Pomo **2 Jgos**
- 3** Guia Interior **1 Pza**
- 4** Porta Jamba **2 Pzas**
- 5** Tope de Seguridad **4 Pzas**
- 6** Tope Lateral **4 Pzas**

**KIT DE ACCESORIOS**

- 1** Escuadra para Riel Inferior **1 Pza**
- 4** Escuadra para Riel Superior **1 Pza**
- 2** Contrador **4 Pzas**
- 5** Soporte para Riel Superior con Jamba **3 Pzas**
- 3** Guia p/ Vidrio Fijo Interior **1 Pza**

**KIT DE ALUMINIO**

- 1** Jamba Lateral **2 Pzas**
- 2** Riel Superior **2 Pzas**
- 3** Riel Inferior **2 Pzas**

Medidas estándar: 1.20 X 2.00    1.50 X 2.00

**CONFIGURACION CORREDIZO-CORREDIZO 6 MM**



**KIT DE HERRAJES**

- 1** Caretillos 5 modelos opcionales **4 Pzas**
- Expuesta 1 Rodamiento    A presión 1 Rodamiento    Expuesta    Oculta    A presión 2 Rodamientos
- 2** Jaladera Pomo **2 Jgos**
- 3** Guia inferior **1 Pza**
- 4** Porta Jamba **2 Pzas**
- 5** Tope de Seguridad **4 Pzas**
- 6** Tope Lateral **4 Pzas**

**KIT DE ALUMINIO**

- 1** Jamba Lateral **2 Pzas**
- Acuario
- Aries
- 2** Riel Superior **1 Pza**
- 3** Riel Inferior **1 Pza**

Medidas estándar: 1.20 X 2.00    1.50 X 2.00    2.00 X 2.00

**CONFIGURACION FIJO-CORREDIZO 6 MM**



**KIT DE HERRAJES**

- 1** Caretillos 5 modelos opcionales **4 Pzas**
- Expuesta 1 Rodamiento    A presión 1 Rodamiento    Expuesta    Oculta    A presión 2 Rodamientos
- 2** Jaladera Pomo **1 Jgo**
- 3** Guia inferior **1 Pza**
- 3** Guia p/ Vidrio Fijo Interior **1 Pza**
- 4** Porta Jamba **2 Pzas**
- 5** Tope de Seguridad **2 Pzas**
- 6** Tope Lateral **4 Pzas**
- 7** Contrador **2 Pzas**

**KIT DE ALUMINIO**

- 1** Jamba Lateral **2 Pzas**
- Acuario
- Aries
- 2** Riel Superior **1 Pza**
- 3** Riel Inferior **1 Pza**

Medidas estándar: 1.20 X 2.00    1.50 X 2.00    2.00 X 2.00

**CUBRIMOS TODAS LAS CONFIGURACIONES PARA BAÑOS CON UNA SOLUCIÓN INTEGRAL.**

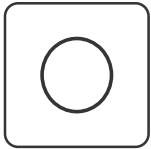

**SISTEMA CON  
BARRENO**



**AJUSTE EN  
DESCUADRE**



**MEDIDAS  
ESPECIALES**



**RODAMIENTO  
ANTICORROSIVO**

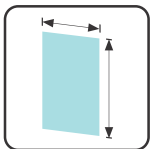

**MEDIDAS**  
1.20 x 2.00 Mts.  
1.50 x 2.00 Mts.  
2.00 x 2.00 Mts.

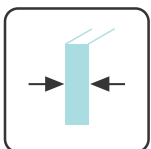

**ESPELOR  
DEL VIDRIO**  
8-10 mm

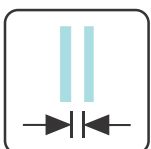

**ESPACIO  
ENTRE HOJAS**  
5 mm



# Escorpión

Sistema corredizo para baño con vidrio de 8-10 mm

# Sistema Corredizo con Perfilera Perimetral



**NOTA.**  
La instalación de nuestros sistemas corredizos con Perfilera Perimetral, exigen ser a escuadra y a nivel para una mayor eficiencia.



**MEDIDAS ESTANDAR:** 1.20 x 2.00 Mts. / 1.50 x 2.00 Mts. / 2.00 x 2.00 Mts.

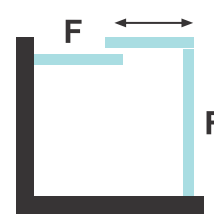
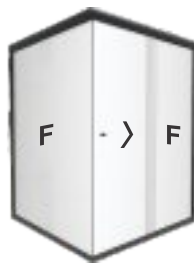
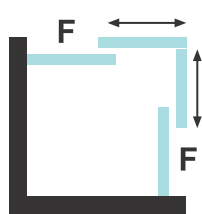

**MEDIDAS ESTANDAR:** 1.00 x 2.00 Mts. / 1.20 x 2.00 Mts.

## Medidas

**Riel Superior**

A) 77 mm

B) 69 mm

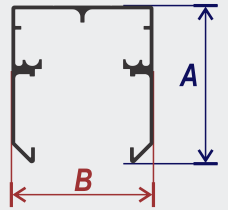

**Jamba Lateral**

A) 16 mm

B) 46 mm



**Riel Inferior**

A) 19 mm

B) 42 mm



# Sistema Corredizo Línea Diamante

Línea Diamante



**MEDIDAS ESTANDAR:** 1.20 x 2.00 Mts. / 1.50 x 2.00 Mts. / 2.00 x 2.00 Mts.

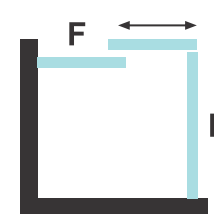
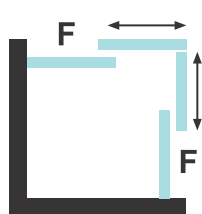

**MEDIDAS ESTANDAR:** 1.00 x 2.00 Mts. / 1.20 x 2.00 Mts.

**NOTA.** La instalación de nuestros sistemas corredizos sin Jamba Lateral y en nuestra Línea Diamante, exigen ser a plomo y a escuadra para una mayor eficiencia.

## Medidas

**Riel Superior**

A) 77 mm

B) 69 mm

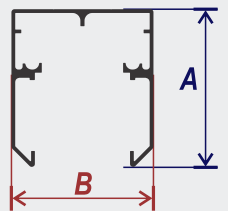

## RIEL INFERIOR TRANSPARENTE



A) 19 mm

B) 42 mm

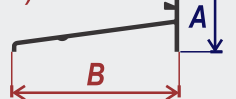

## Perfilería Perimetral

## Línea Diamante

**F1**  
Distancia de la base del centrador a la base superior del Riel

**F2**  
Distancia de la base a ras de suelo a la base de asentamiento de la guía inferior.

**F3**  
Holgura entre base superior y vidrio

**F4**  
Holgura entre piso y vidrio

**Traslape de vidrio.**  
Ancho del cristal  
(Base÷ 2) + ( 25mm).

**Nota:**  
El descuento para la altura de las hojas fijas, es igual a la suma de "F1" y "F2"

El descuento para la altura de las hojas corredizas, es igual a la suma de "F3" y "F4"

**DESCUENTO PARA LA ALTURA DE LA JAMBA UNIVERSAL**

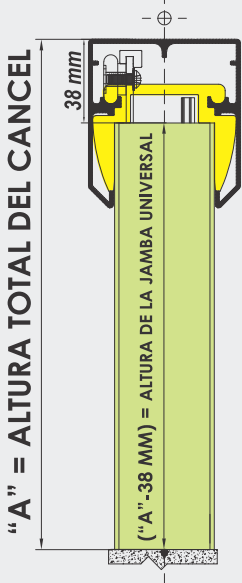

**Carretilla Expuesta (CON BARRENO)**

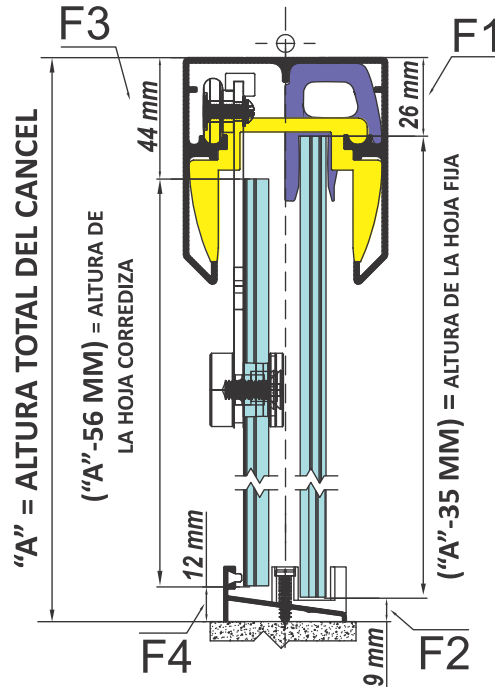

**Carretilla Expuesta (CON BARRENO)**

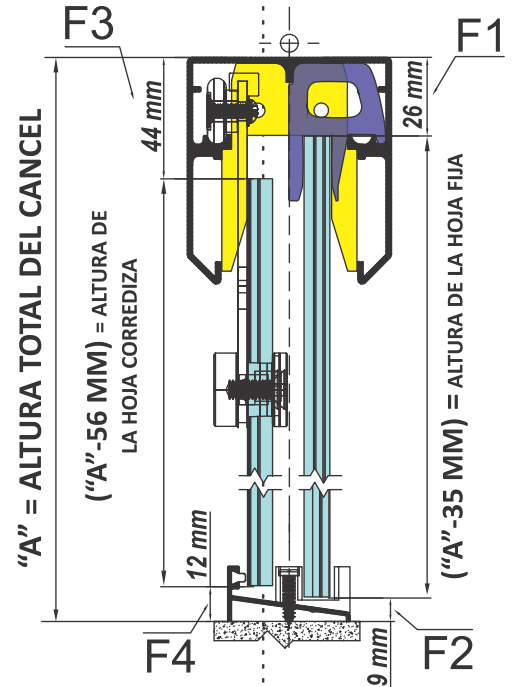

**Carretilla Oculta (CON BARRENO)**

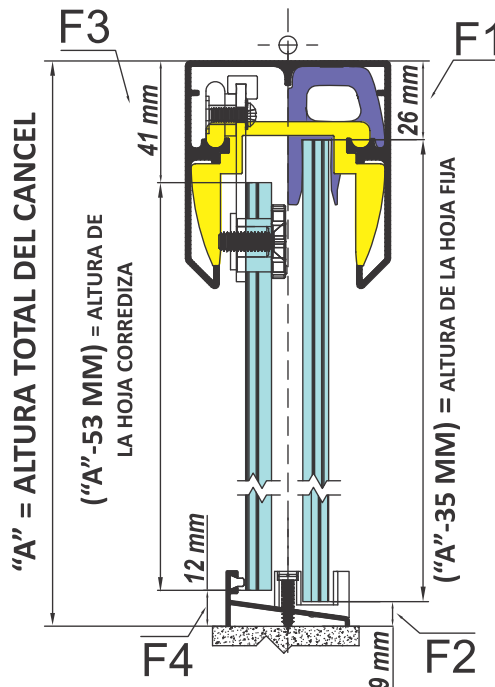

**Carretilla Oculta (CON BARRENO)**

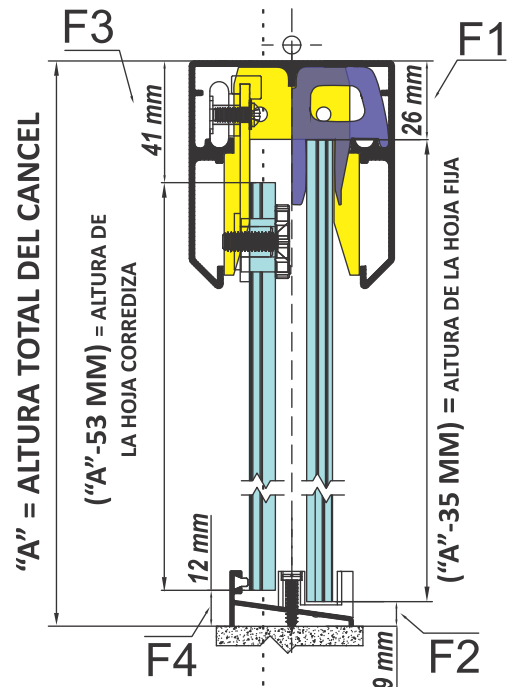

# Corte y Alzado Cancel Recto Corredizo/Corredizo

Compatible con:



- ① RIEL SUPERIOR
- ② RIEL INFERIOR
- ③ JAMBA LATERAL
- ④ TOPE DE SEGURIDAD
- ⑤ CARRETILLA OCULTA

- ⑥ GUÍA INFERIOR DE 9 mm
- ⑦ JALADERA POMO DE 9 mm
- ⑧ PORTA JAMBA
- ⑨ TOPE LATERAL
- ⑩ PIJAS Y TAQUETES



Cancel Recto Corredizo/Corredizo

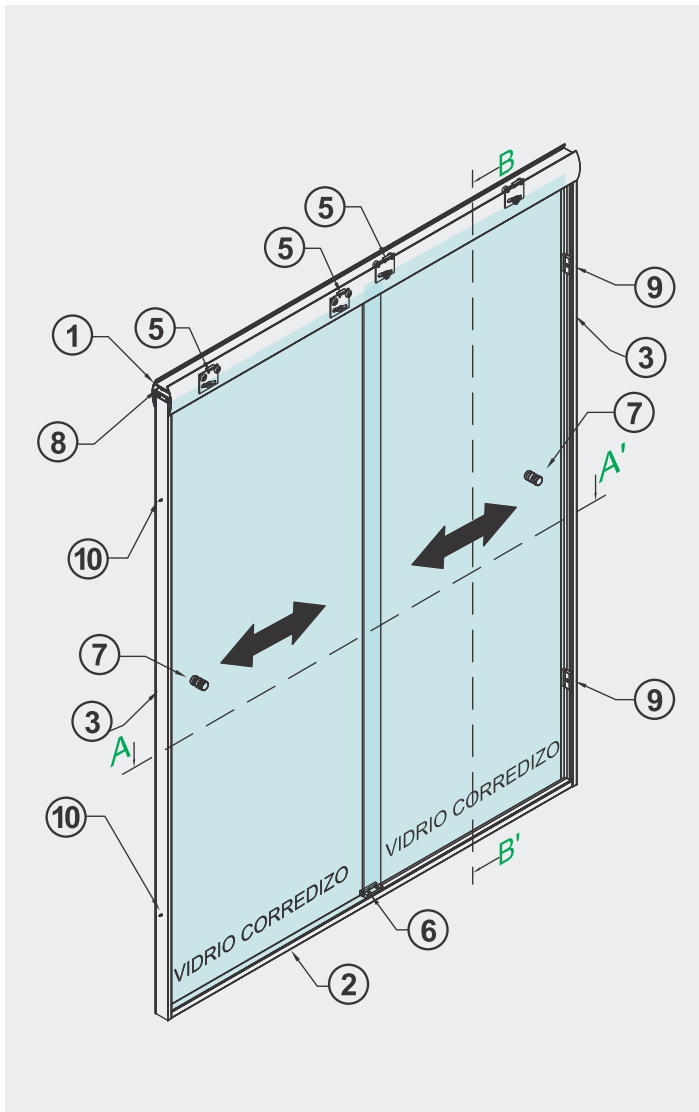

## CORTE LATERAL B-B'

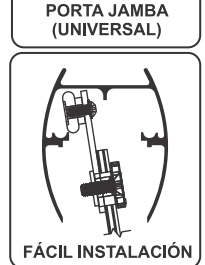
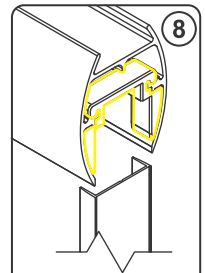
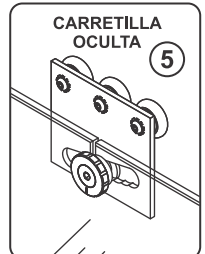
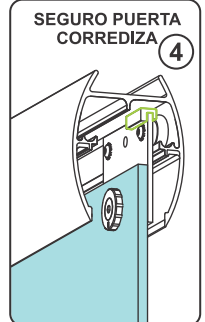
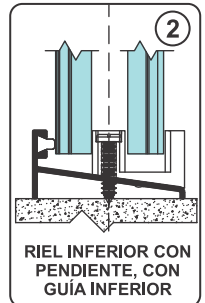
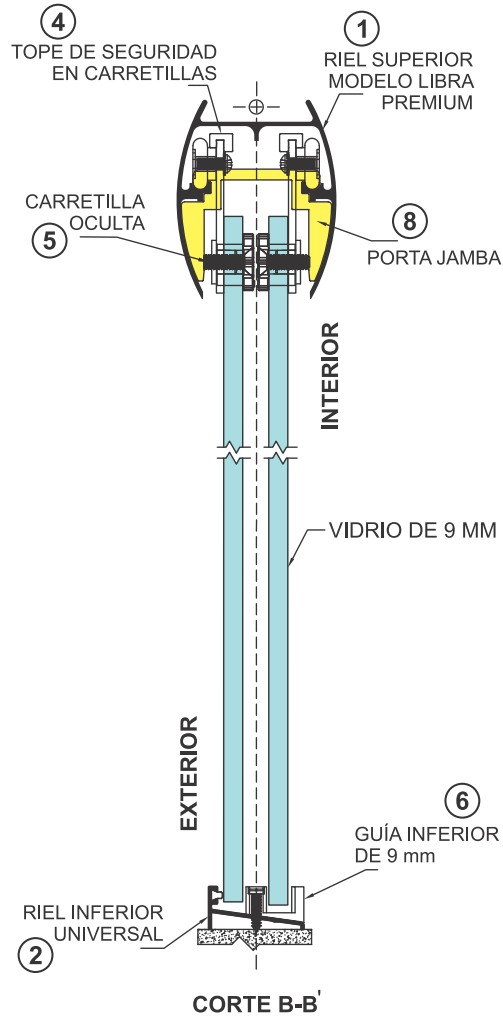

## CORTE SUPERIOR A-A'

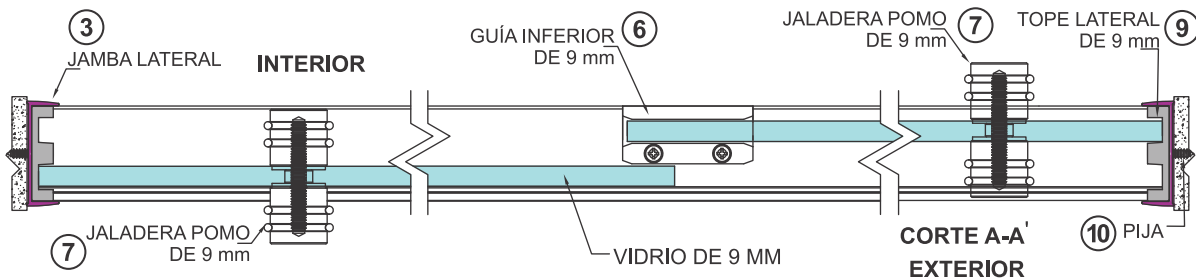

# Corte y Alzado Cancel Recto Corredizo/Fijo Interior



Cancel Recto  
Corredizo/Fijo Interior

- |                      |                          |                     |
|----------------------|--------------------------|---------------------|
| ①  RIEL SUPERIOR     | ⑤  CARRETILLA OCULTA     | ⑨  PORTA JAMBA      |
| ②  RIEL INFERIOR     | ⑥  GUÍA INFERIOR DE 9 mm | ⑩  TOPE LATERAL     |
| ③  JAMBA LATERAL     | ⑦  CENTRADOR             | ⑪  PIJAS Y TAQUETES |
| ④  TOPE DE SEGURIDAD | ⑧  JALADERA POMO DE 9 mm |                     |

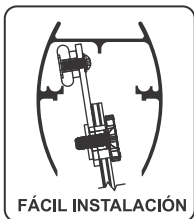
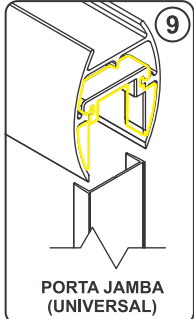
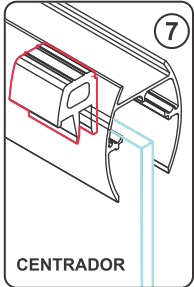
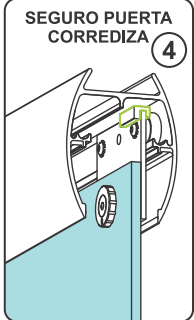
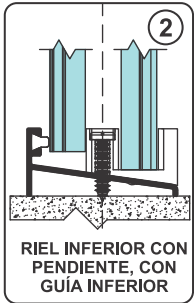

## CORTE LATERAL B-B'

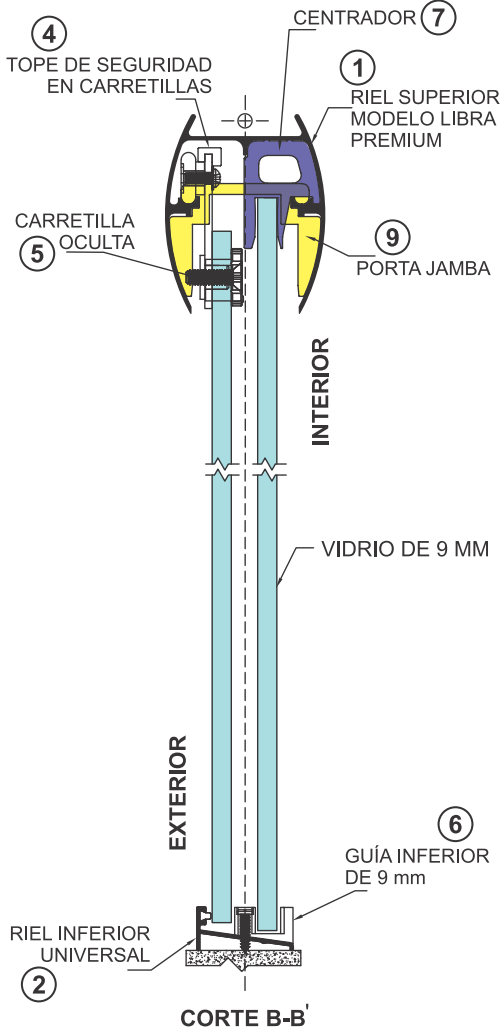

## Compatible con

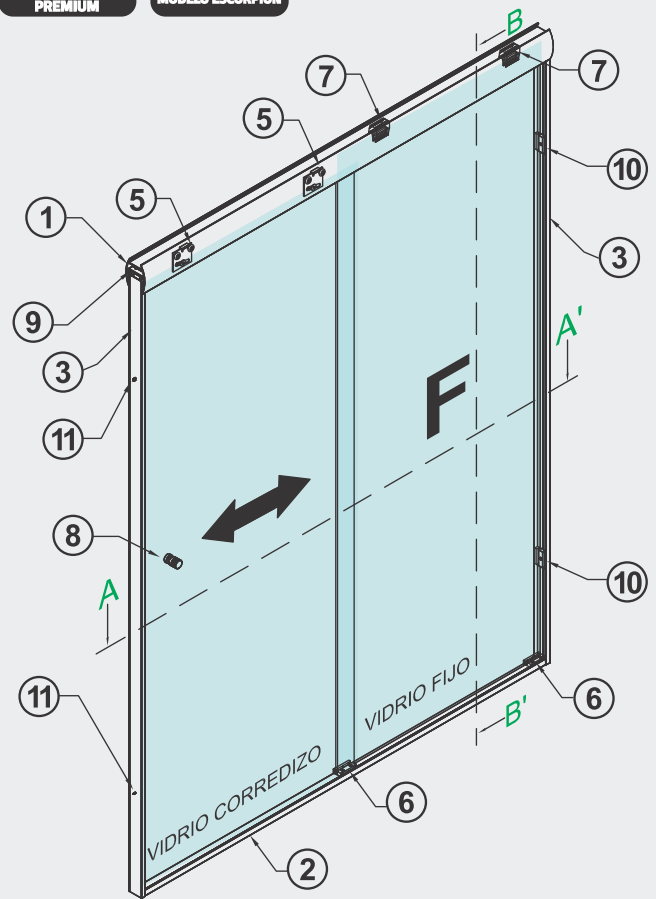
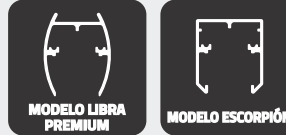

## CORTE SUPERIOR A-A'

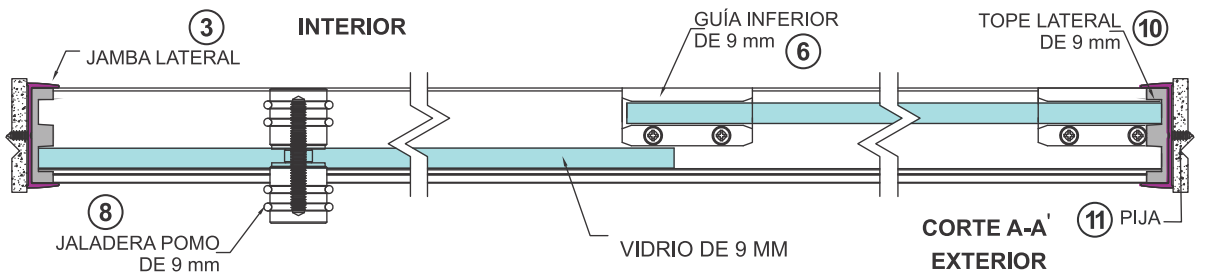

# Corte y Alzado Cancel Recto Fijo Exterior/Corredizo

- ① RIEL SUPERIOR
- ② RIEL INFERIOR
- ③ JAMBA LATERAL
- ④ TOPE DE SEGURIDAD

- ⑤ CARRETILLA OCULTA
- ⑥ GUÍA INFERIOR DE 9 mm
- ⑦ CENTRADOR
- ⑧ JALADERA POMO DE 9 mm

- ⑨ PORTA JAMBA
- ⑩ TOPE LATERAL
- ⑪ SOPORTE PARA VIDRIO FIJO AL EXT.
- ⑫ PIJAS Y TAQUETES



Cancel Recto Fijo Exterior/Corredizo

## Compatible con

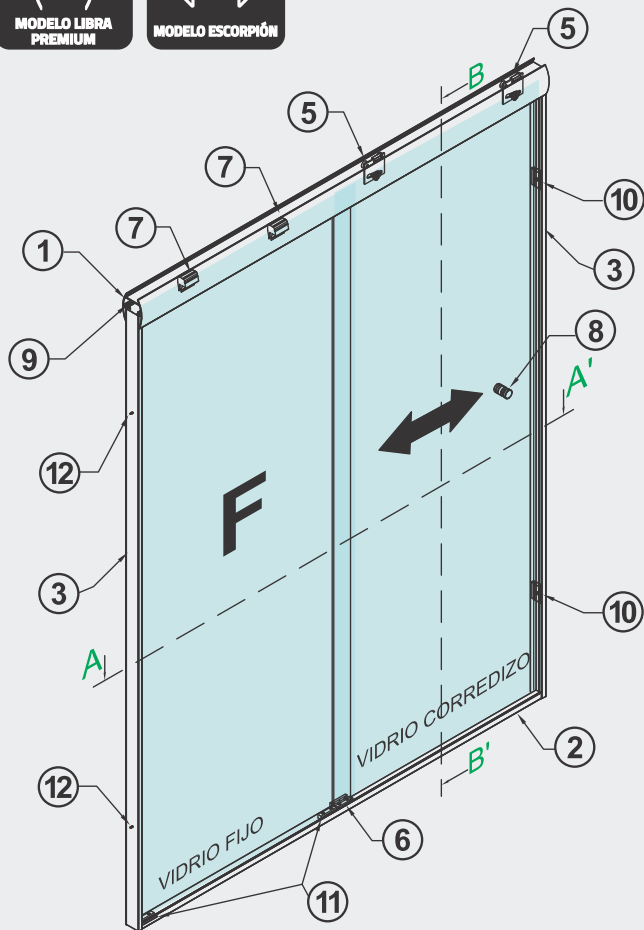
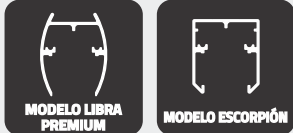

## CORTE LATERAL B-B'

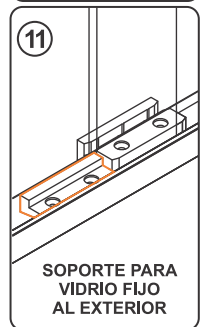
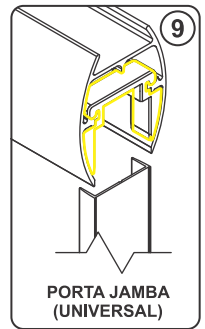
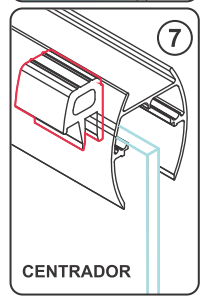
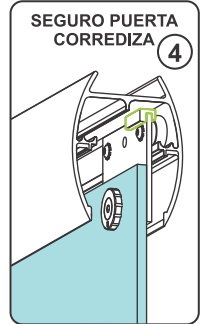
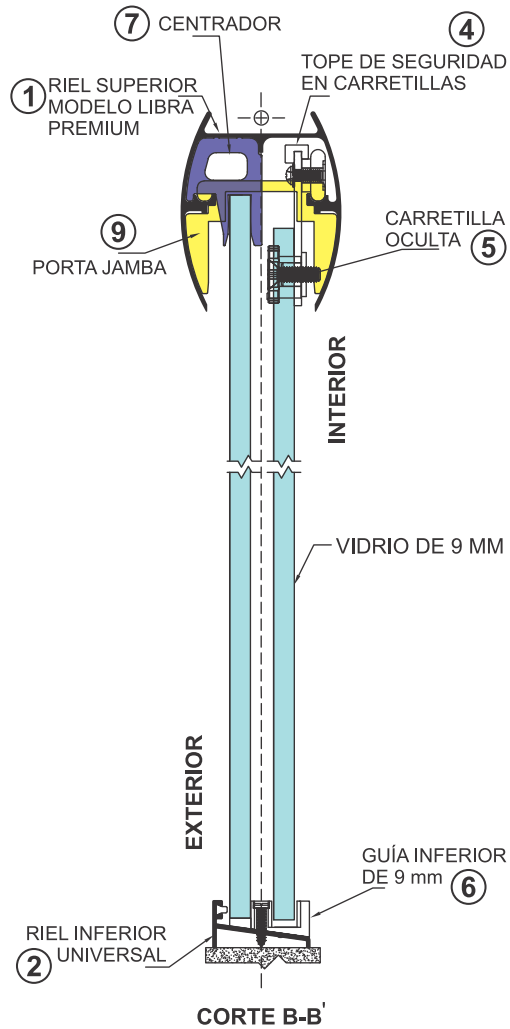

## CORTE SUPERIOR A-A'

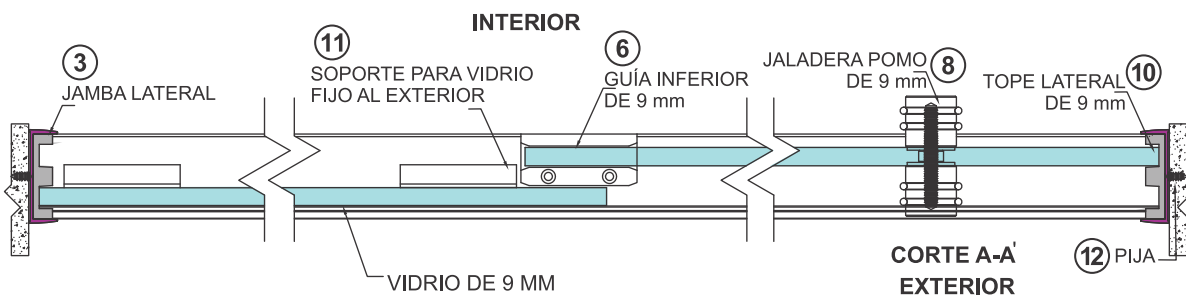



# Corte y Alzado Cancel en Escuadra Fijo Exterior/Corredizo-Corredizo/Fijo Exterior



Cancel en Escuadra Fijo Exterior/Corredizo-Corredizo/Fijo Exterior

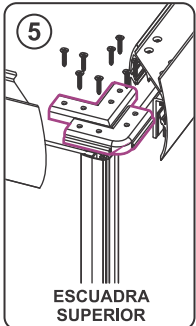

ESCUADRA SUPERIOR



ESCUADRA INFERIOR

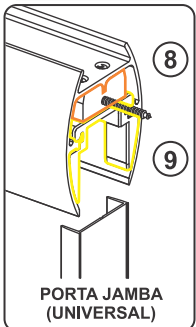

PORTA JAMBA (UNIVERSAL)

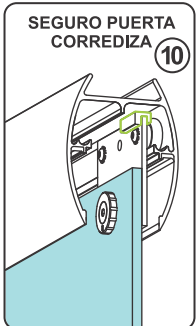

SEGURO PUERTA CORREDIZA



FÁCIL INSTALACIÓN

Compatible con

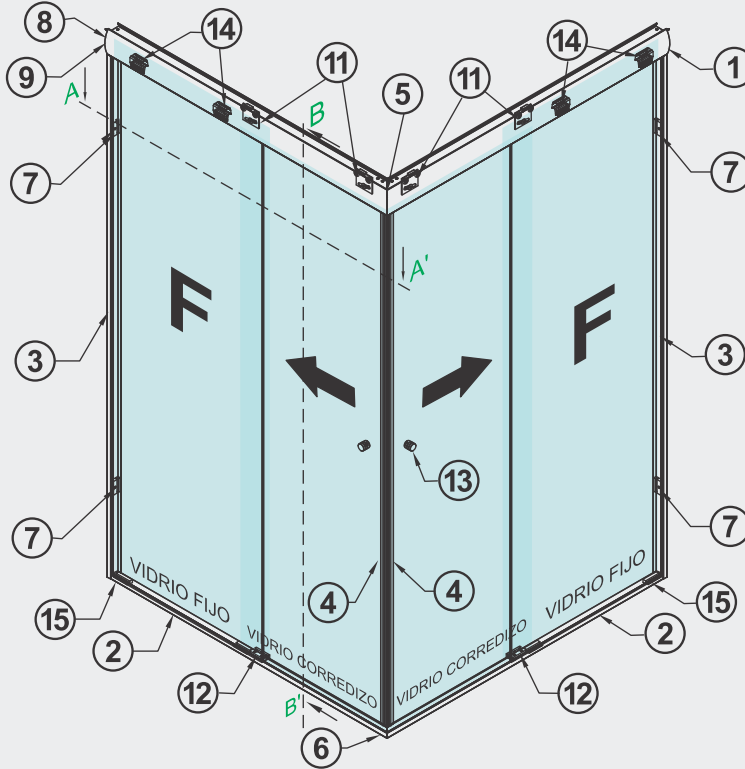

- ① RIEL SUPERIOR
- ② RIEL INFERIOR
- ③ JAMBA LATERAL
- ④ MOLDURA IMÁN
- ⑤ ESCUADRA SUPERIOR
- ⑥ ESCUADRA INFERIOR
- ⑦ TOPE LATERAL
- ⑧ SOPORTE PARA RIEL SUPERIOR CON JAMBA
- ⑨ PORTA JAMBA
- ⑩ TOPE DE SEGURIDAD
- ⑪ CARRETILLA OCULTA
- ⑫ GUÍA INFERIOR DE 9 mm
- ⑬ JALADERA POMO DE 9 mm
- ⑭ CENTRADOR
- ⑮ SOPORTE PARA VIDRIO FIJO AL EXTERIOR
- ⑯ PIJAS Y TAQUETES

## CORTE LATERAL B-B'

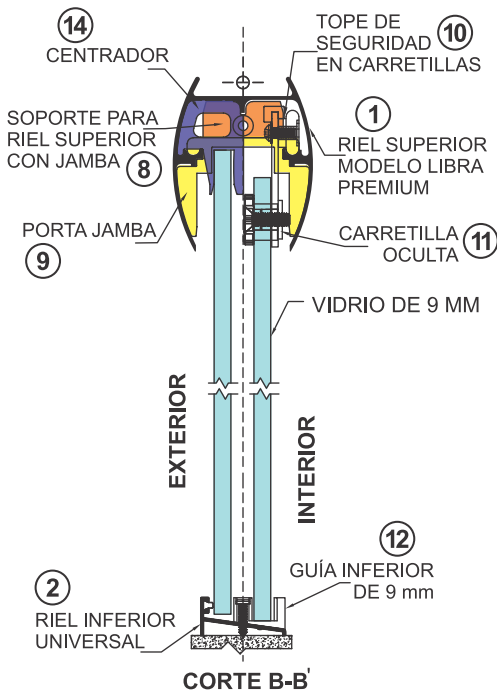

## CORTE SUPERIOR A-A'

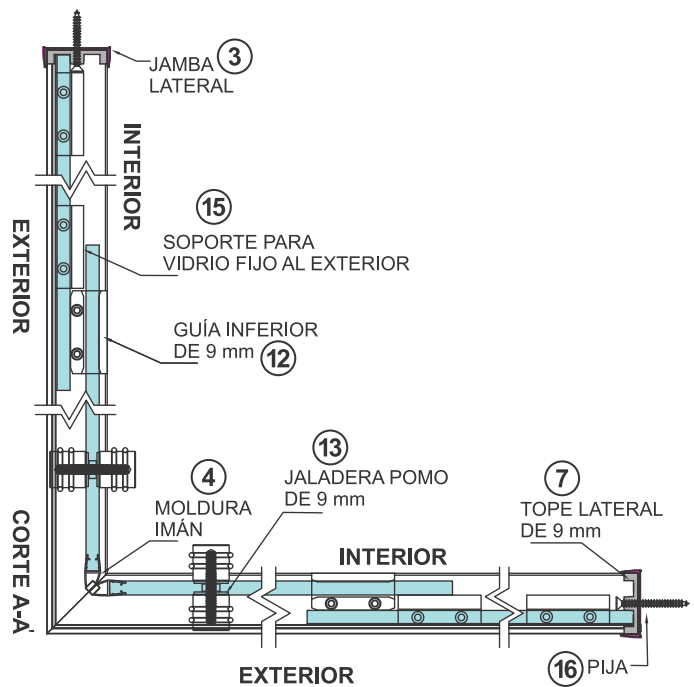

# Corte y Alzado Cancel en Escuadra Fijo Interior/Corredizo-Corredizo/Fijo Interior

- ①  RIEL SUPERIOR
- ②  RIEL INFERIOR
- ③  JAMBA LATERAL
- ④  MOLDURA IMÁN
- ⑤  ESCUADRA SUPERIOR
- ⑥  ESCUADRA INFERIOR
- ⑦  TOPE LATERAL
- ⑧  SOPORTE PARA RIEL SUPERIOR CON JAMBA
- ⑨  PORTA JAMBA
- ⑩  TOPE DE SEGURIDAD
- ⑪  CARRETILLA OCULTA
- ⑫  GUÍA INFERIOR DE 9 mm
- ⑬  JALADERA POMO DE 9 mm
- ⑭  CENTRADOR
- ⑮  PIJAS Y TAQUETES

Compatible con

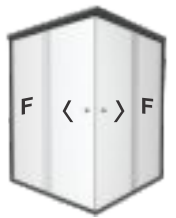
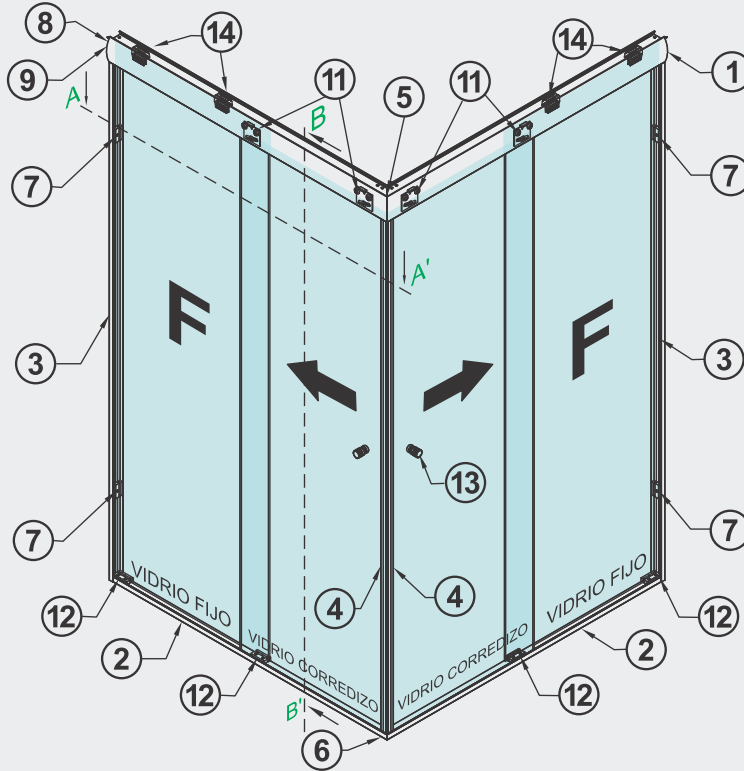
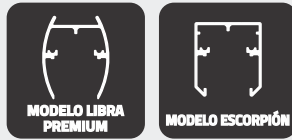

Cancel en Escuadra Fijo Interior/Corredizo-Corredizo/Fijo Interior

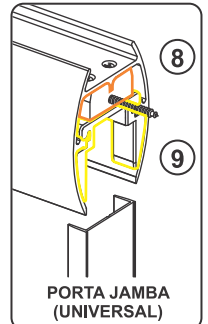
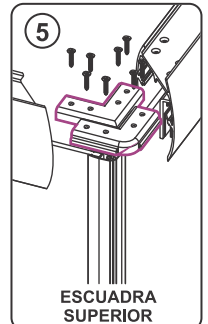
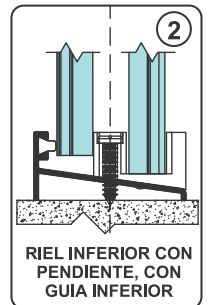

## CORTE SUPERIOR A-A'

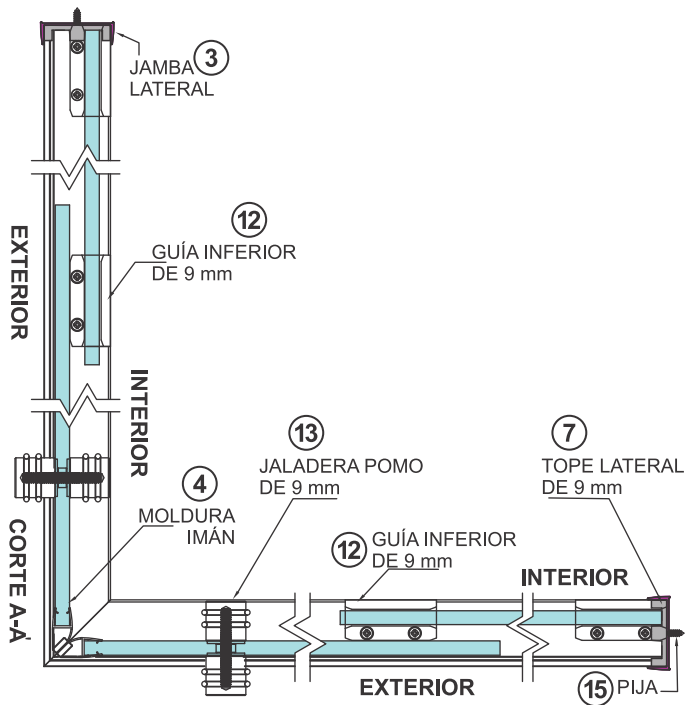

## CORTE LATERAL B-B'

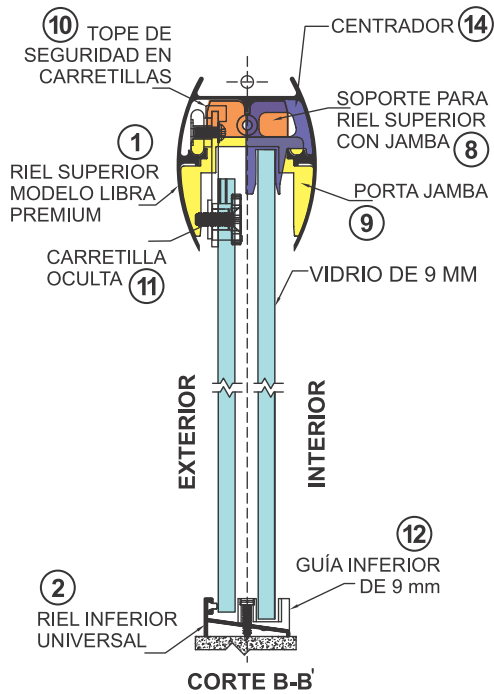

# Corte y Alzado Cancel en Escuadra Fijo Exterior-Corredizo/Fijo Interior



Cancel en Escuadra Fijo Exterior-Corredizo/Fijo Interior

Compatible con

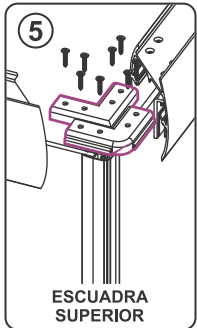

ESCUADRA SUPERIOR

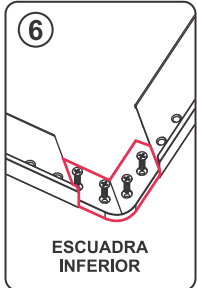

ESCUADRA INFERIOR

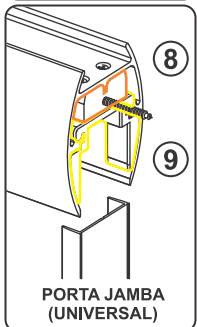

PORTA JAMBA (UNIVERSAL)

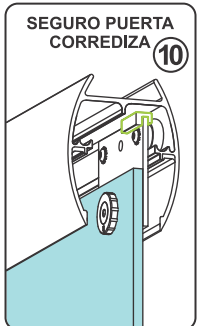

SEGURO PUERTA CORREDIZA



FÁCIL INSTALACIÓN

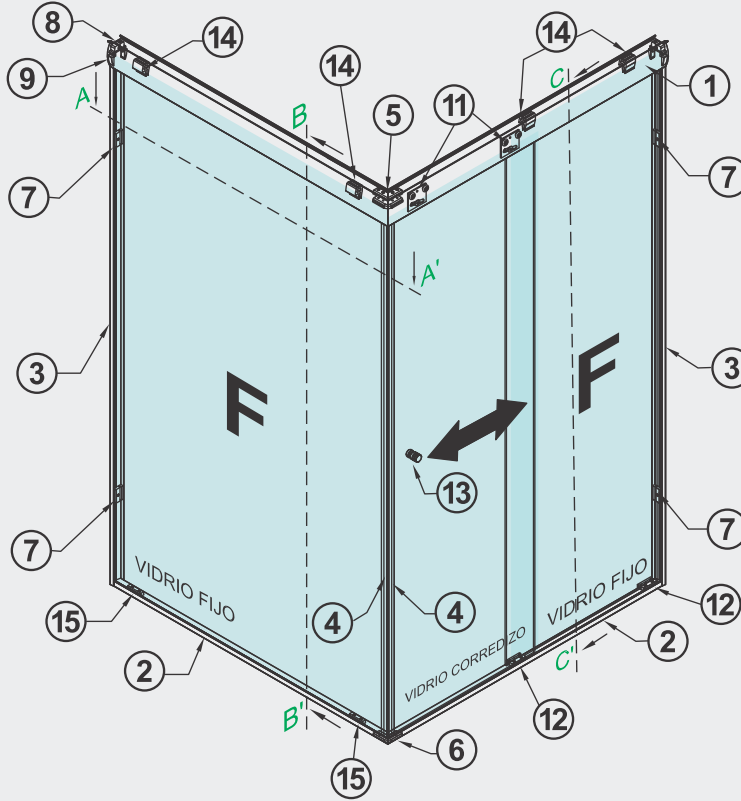

- ① RIEL SUPERIOR
- ② RIEL INFERIOR
- ③ JAMBA LATERAL
- ④ MOLDURA IMÁN
- ⑤ ESCUADRA SUPERIOR
- ⑥ ESCUADRA INFERIOR
- ⑦ TOPE LATERAL
- ⑧ SOPORTE PARA RIEL SUPERIOR CON JAMBA
- ⑨ PORTA JAMBA
- ⑩ TOPE DE SEGURIDAD
- ⑪ CARRETILLA OCULTA
- ⑫ GUÍA INFERIOR DE 9 mm
- ⑬ JALADERA POMO DE 9 mm
- ⑭ CENTRADOR
- ⑮ SOPORTE PARA VIDRIO FIJO AL EXTERIOR
- ⑯ PIJAS Y TAQUETES

## CORTE LATERAL C-C'

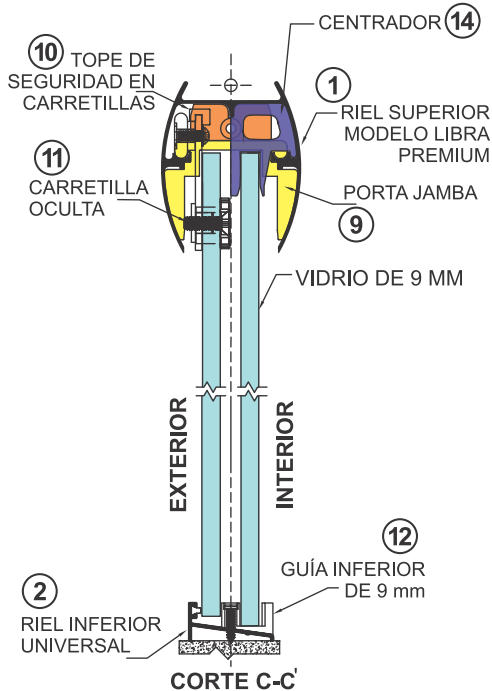

## CORTE SUPERIOR A-A'

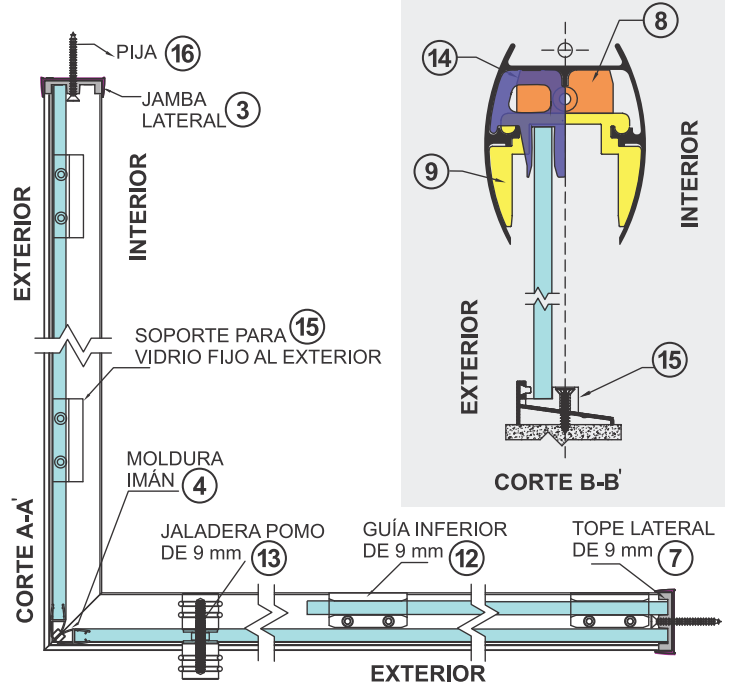

## CORTE LATERAL B-B'

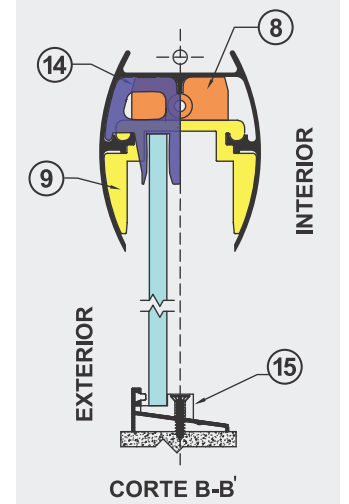

# Corte y Alzado Cancel Recto Corredizo/Corredizo

Línea Diamante



Cancel Recto Corredizo/Corredizo



- 1 RIEL SUPERIOR
- 2 RIEL INFERIOR
- 3 TOPE DE SEGURIDAD
- 4 CARRETILLA OCULTA
- 5 MOLDURA BURBUJA

- 6 SOPORTE PARA RIEL SUPERIOR SIN JAMBA
- 7 GUÍA INFERIOR DE 9 mm
- 8 JALADERA POMO DE 9 mm
- 9 PIJAS Y TAQUETES



Compatible con:

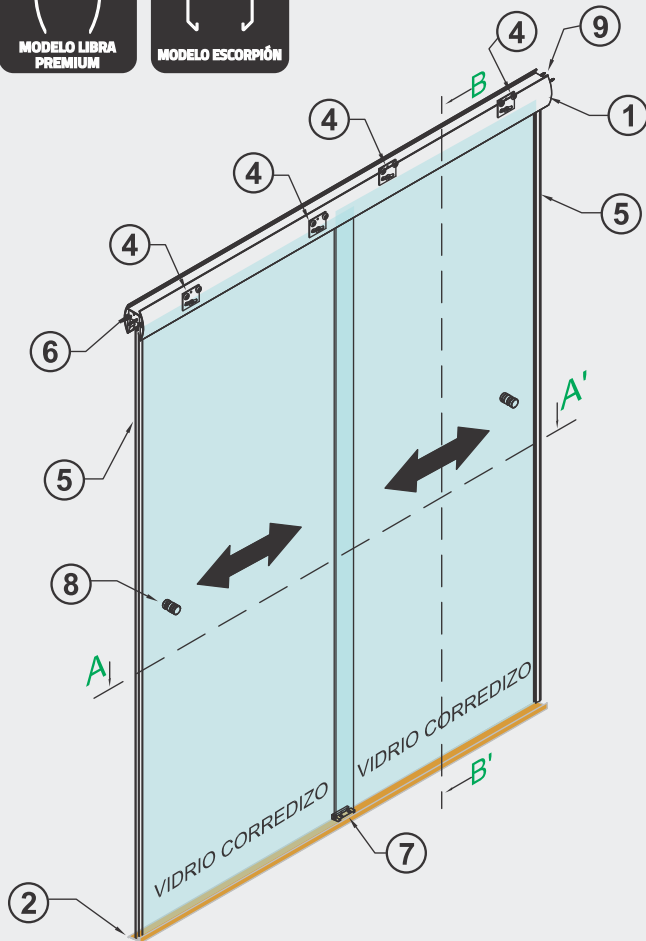

## CORTE LATERAL B-B'

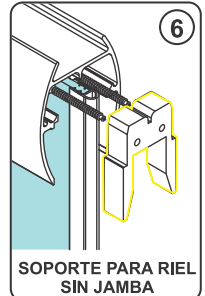
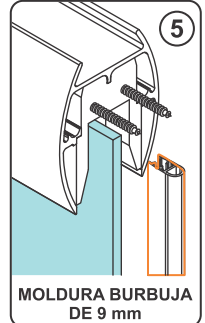
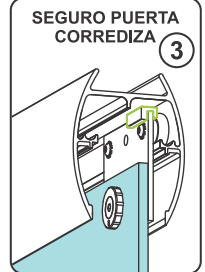
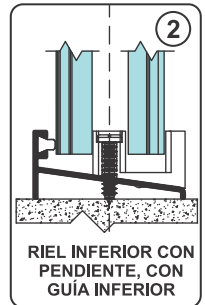
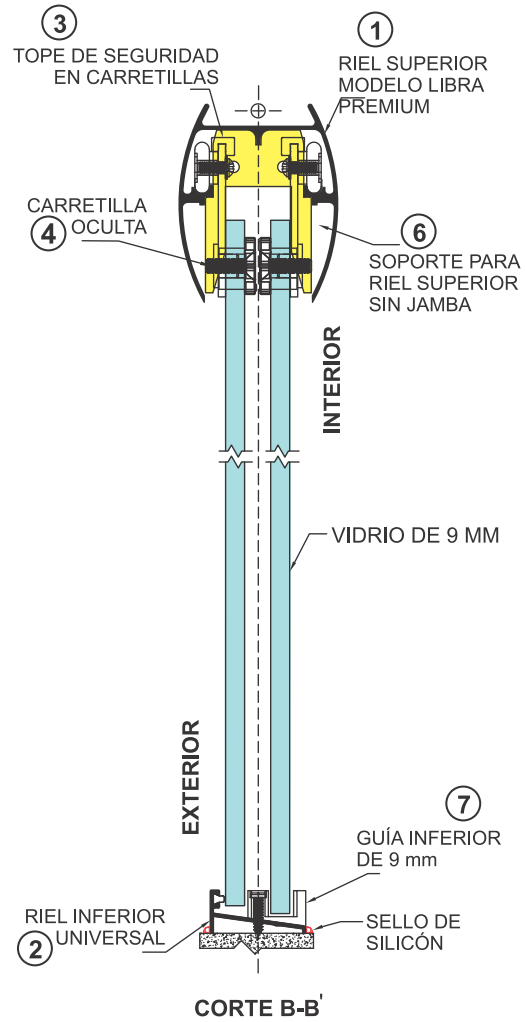

## CORTE SUPERIOR A-A'

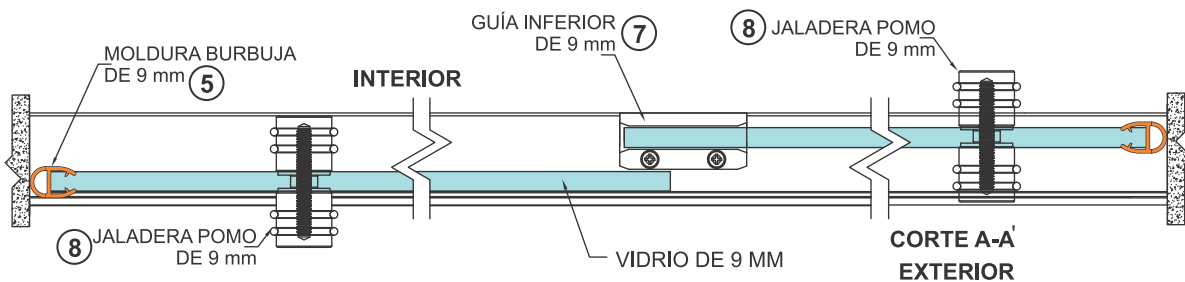



- |                      |   |
|----------------------|---|
| ①  RIEL SUPERIOR     | ⑥  GUÍA INFERIOR DE 9 mm                |
| ②  RIEL INFERIOR ◆   | ⑦  CENTRADOR                            |
| ③  MOLDURA BURBUJA   | ⑧  JALADERA POMO DE 9 mm                |
| ④  TOPE DE SEGURIDAD | ⑨  SOPORTE PARA RIEL SUPERIOR SIN JAMBA |
| ⑤  CARRETILLA OCULTA | ⑩  PIJAS Y TAQUETES                     |



Cancel Recto Corredizo/Fijo Interior

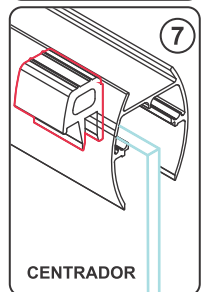
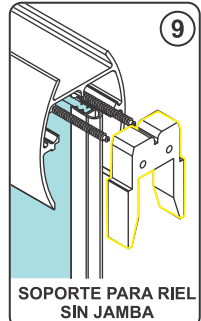
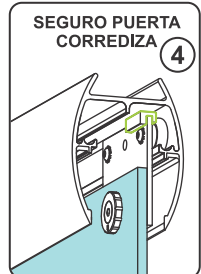
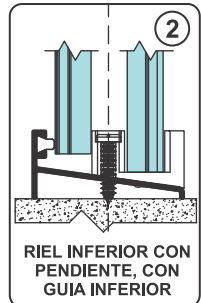

## CORTE LATERAL B-B'

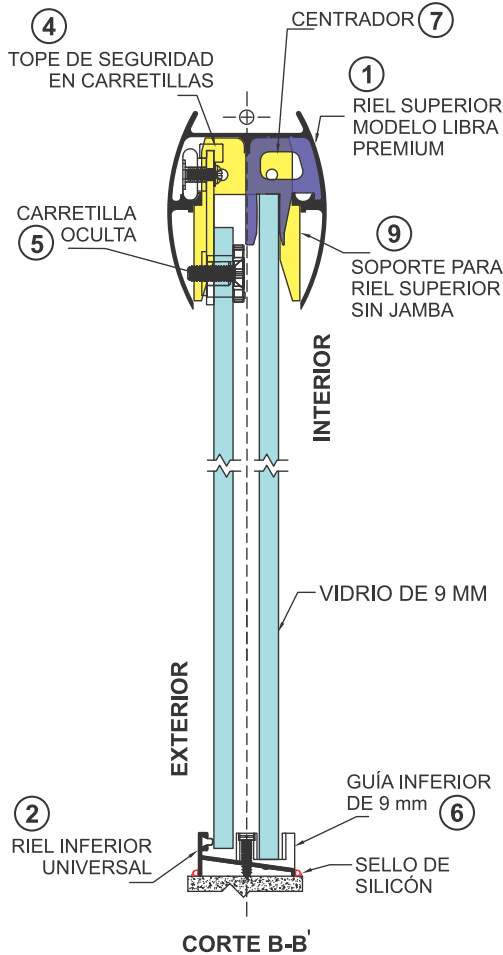

Compatible con:

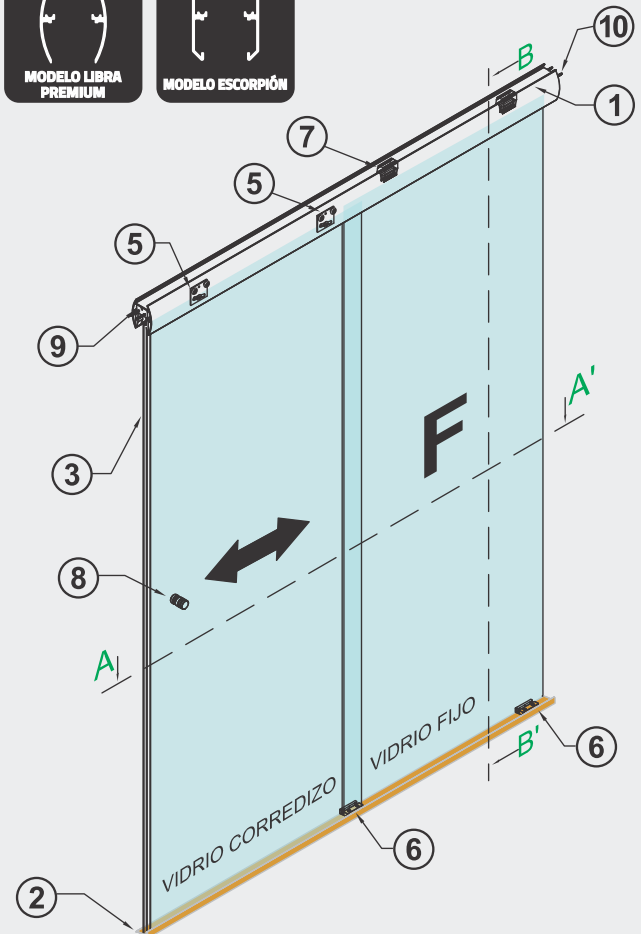
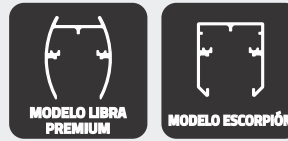

## CORTE SUPERIOR A-A'

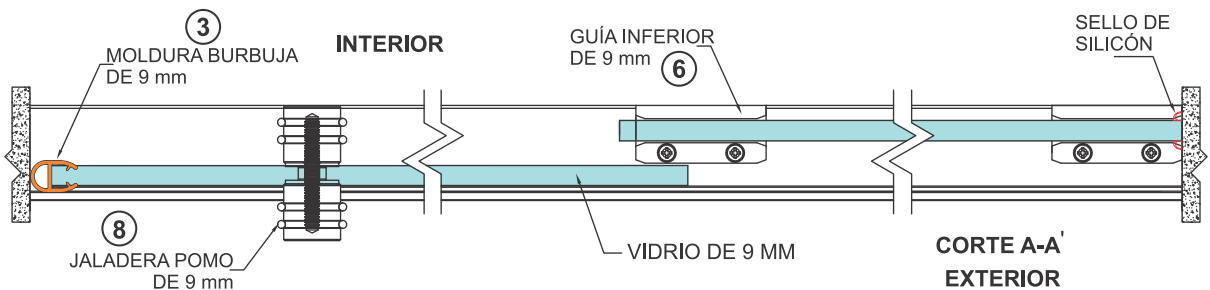



Cancel Recto Fijo Exterior/Corredizo



- ① RIEL SUPERIOR
- ② RIEL INFERIOR
- ③ MOLDURA BURBUJA
- ④ TOPE DE SEGURIDAD
- ⑤ CARRETILLA OCULTA
- ⑥ GUÍA INFERIOR DE 9 mm
- ⑦ CENTRADOR
- ⑧ JALADERA POMO DE 9 mm
- ⑨ SOPORTE PARA RIEL SUPERIOR SIN JAMBA
- ⑩ SOPORTE PARA VIDRIO FIJO AL EXT.
- ⑪ PIJAS Y TAQUETES



Compatible con:

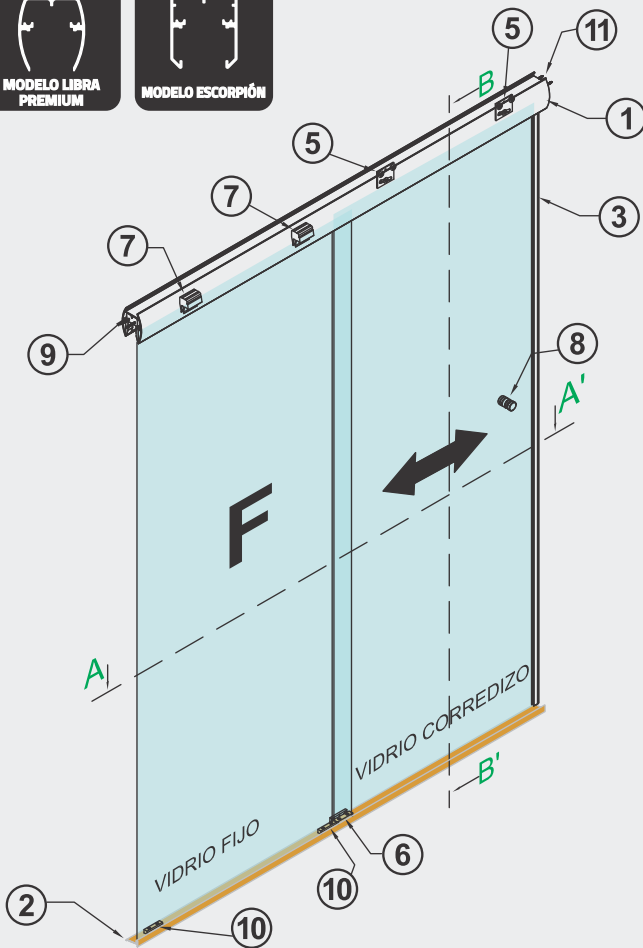
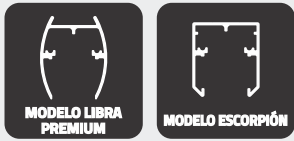

## CORTE LATERAL B-B'

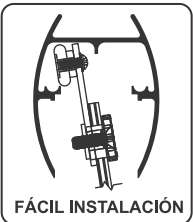
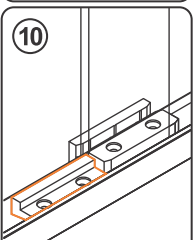
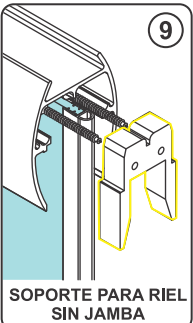
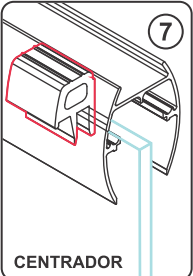
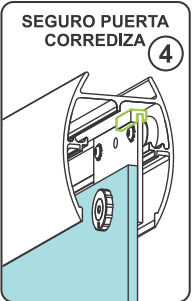
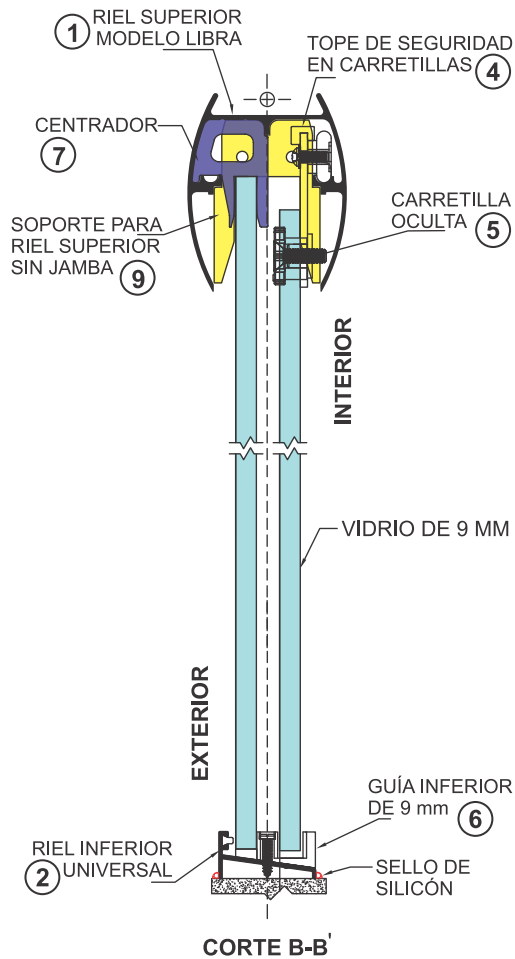

## CORTE SUPERIOR A-A'

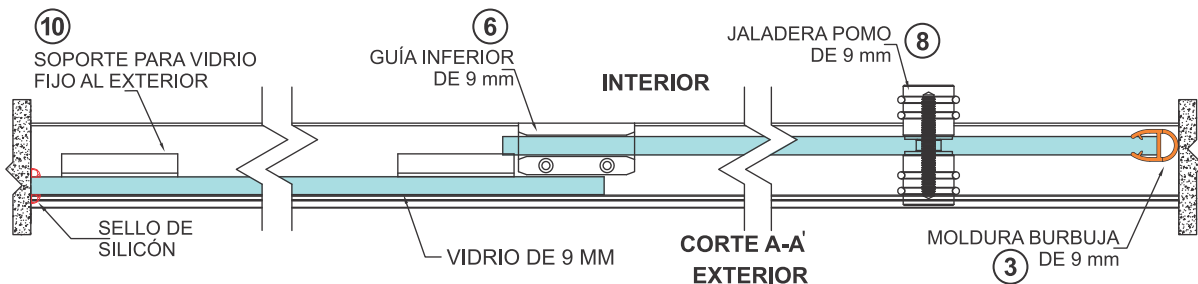

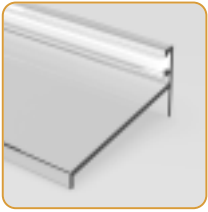

Compatible con



Cancel en Escuadra Fijo Exterior/Corredizo-Corredizo/Fijo Exterior

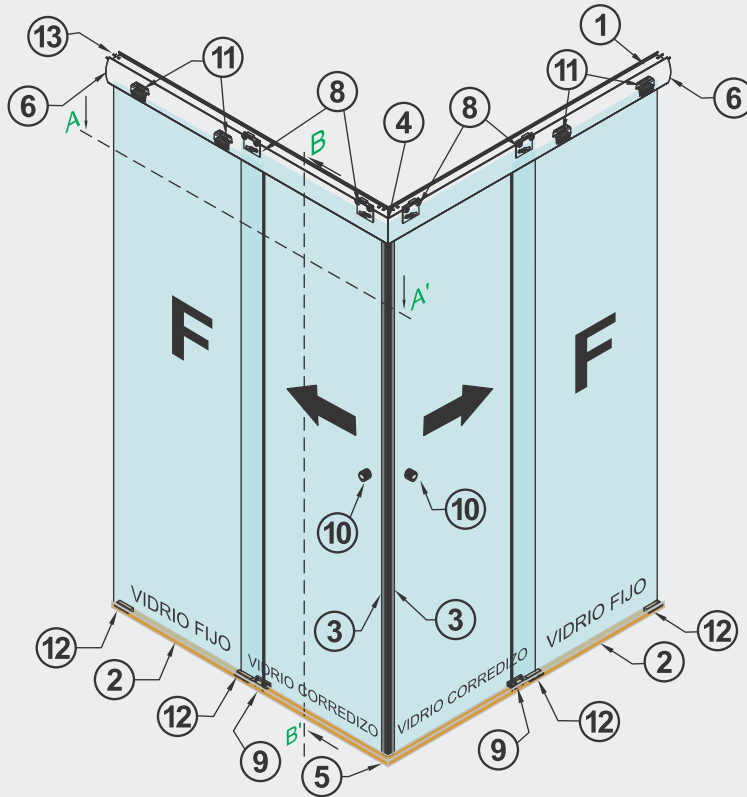
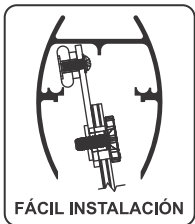
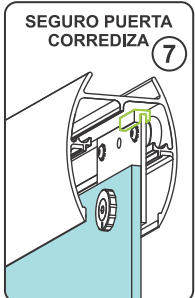
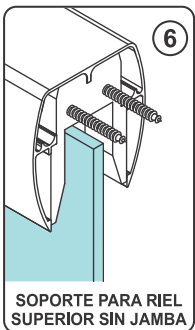
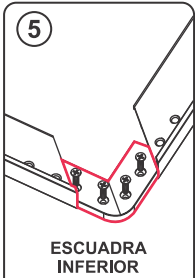
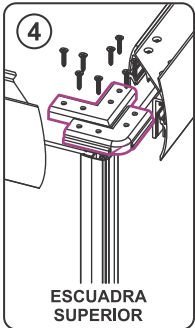

- 1 RIEL SUPERIOR
- 2 RIEL INFERIOR
- 3 MOLDURA IMÁN
- 4 ESCUADRA SUPERIOR
- 5 ESCUADRA INFERIOR
- 6 SOPORTE PARA RIEL SUPERIOR SIN JAMBA
- 7 TOPE DE SEGURIDAD
- 8 CARRETILLA OCULTA
- 9 GUÍA INFERIOR DE 9 mm
- 10 JALADERA POMO DE 9 mm
- 11 CENTRADOR
- 12 SOPORTE PARA VIDRIO FIJO AL EXTERIOR
- 13 PIJAS Y TAQUETES

**CORTE LATERAL B-B'**

**CORTE SUPERIOR A-A'**

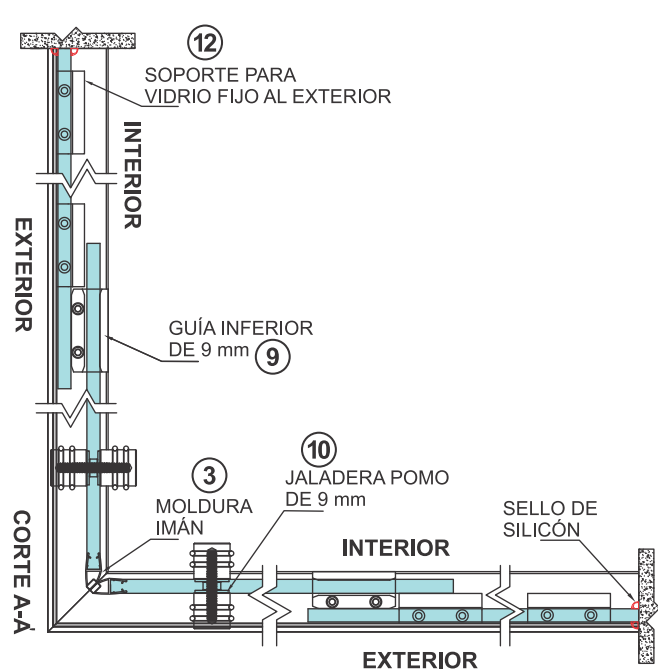
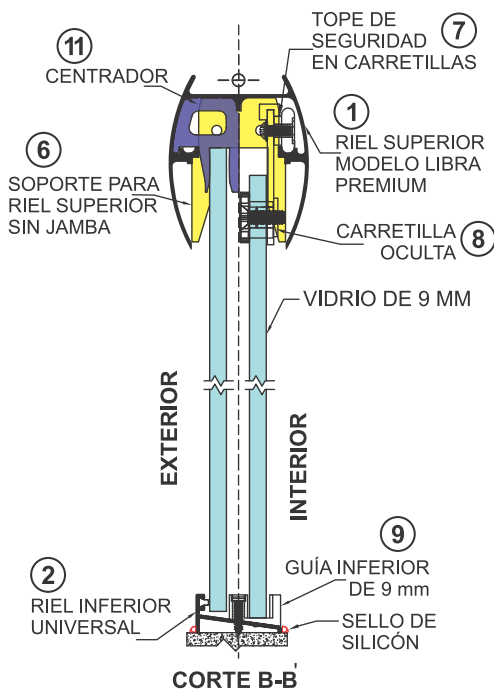

# Corte y Alzado Cancel en Escuadra Fijo Interior/Corredizo-Corredizo/Fijo Interior



Cancel en Escuadra Fijo Interior/Corredizo-Corredizo/Fijo Interior



Compatible con



- ① RIEL SUPERIOR
- ② RIEL INFERIOR ◆
- ③ MOLDURA IMÁN
- ④ ESCUADRA SUPERIOR
- ⑤ ESCUADRA INFERIOR
- ⑥ SOPORTE PARA RIEL SUPERIOR SIN JAMBA
- ⑦ TOPE DE SEGURIDAD
- ⑧ CARRETILLA OCULTA
- ⑨ GUÍA INFERIOR DE 9 mm
- ⑩ JALADERA POMO DE 9 mm
- ⑪ CENTRADOR
- ⑫ PIJAS Y TAQUETES

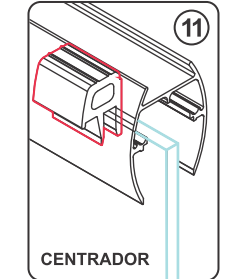
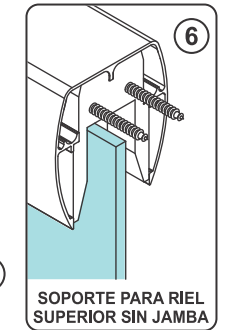
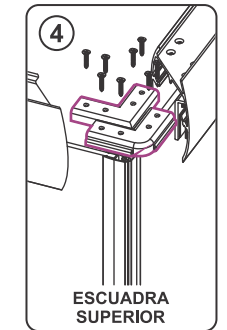
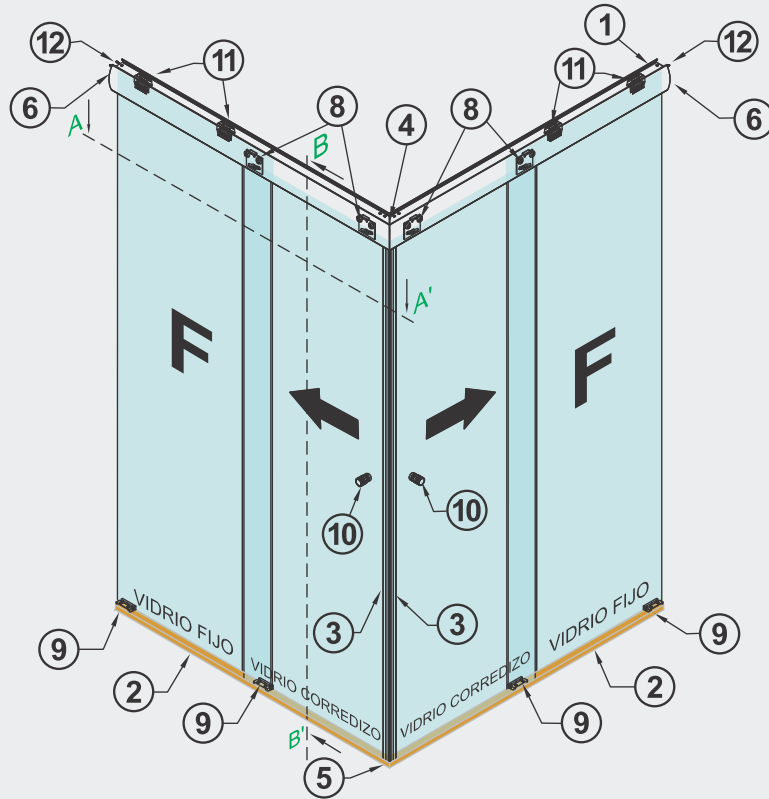

## CORTE SUPERIOR A-A'

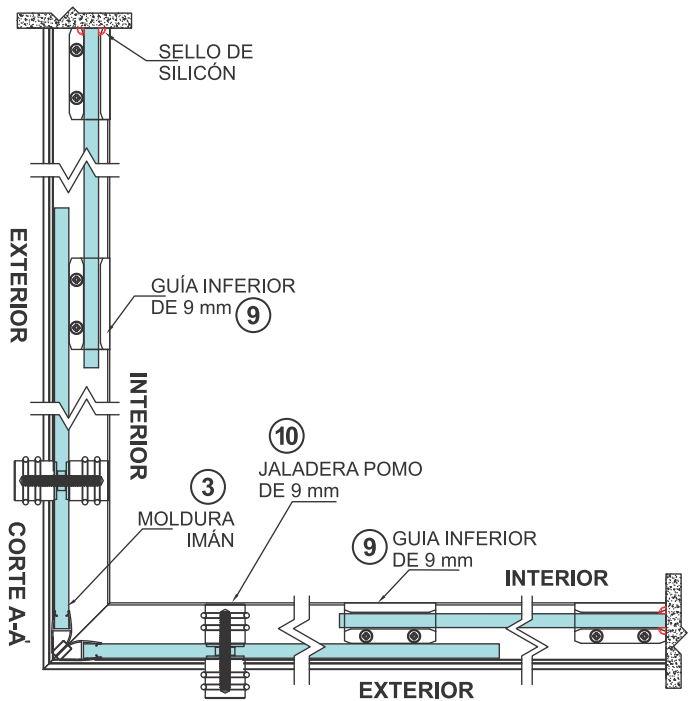

## CORTE LATERAL B-B'

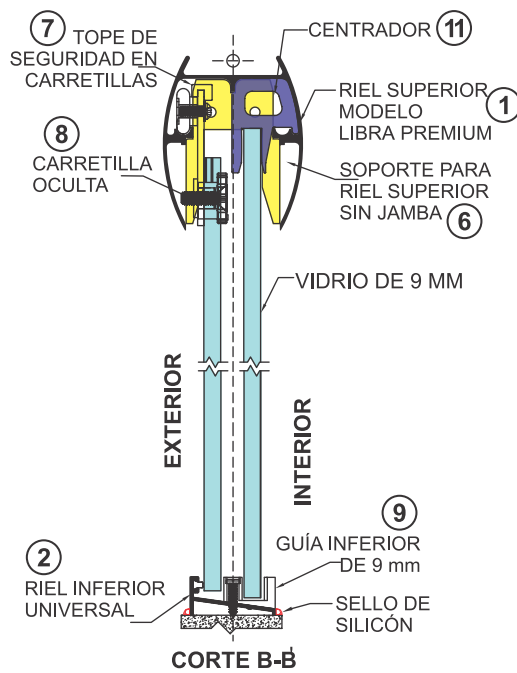



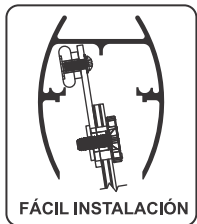
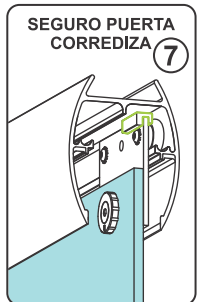
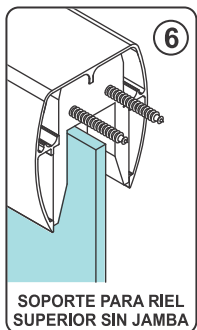
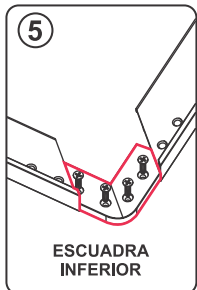
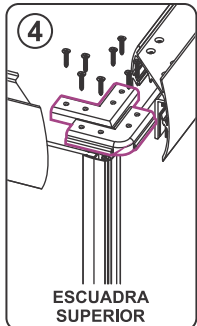

Compatible con

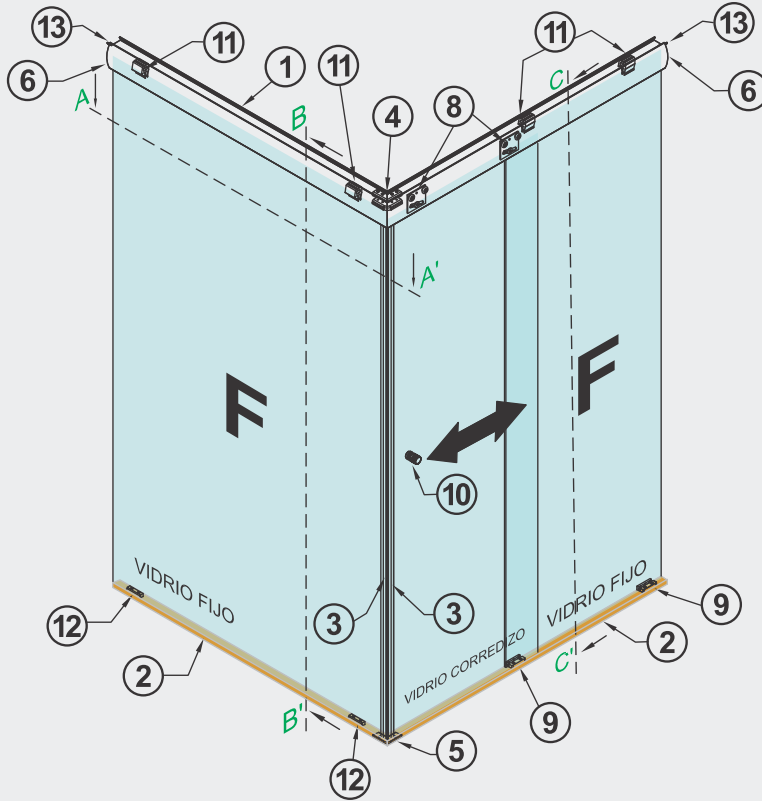

Cancel en Escuadra Fijo Exterior-Corredizo/Fijo Interior

- ① RIEL SUPERIOR
- ② RIEL INFERIOR
- ③ MOLDURA IMÁN
- ④ ESCUADRA SUPERIOR
- ⑤ ESCUADRA INFERIOR
- ⑥ SOPORTE PARA RIEL SUPERIOR SIN JAMBA
- ⑦ TOPE DE SEGURIDAD
- ⑧ CARRETILLA OCULTA
- ⑨ GUÍA INFERIOR DE 9 mm
- ⑩ JALADERA POMO DE 9 mm
- ⑪ CENTRADOR
- ⑫ SOPORTE PARA VIDRIO FIJO AL EXTERIOR
- ⑬ PIJAS Y TAQUETES

**CORTE LATERAL C-C'**

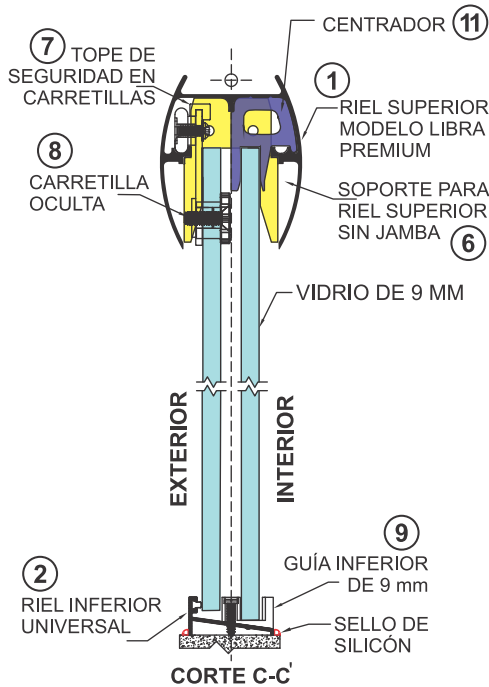

**CORTE SUPERIOR A-A'**

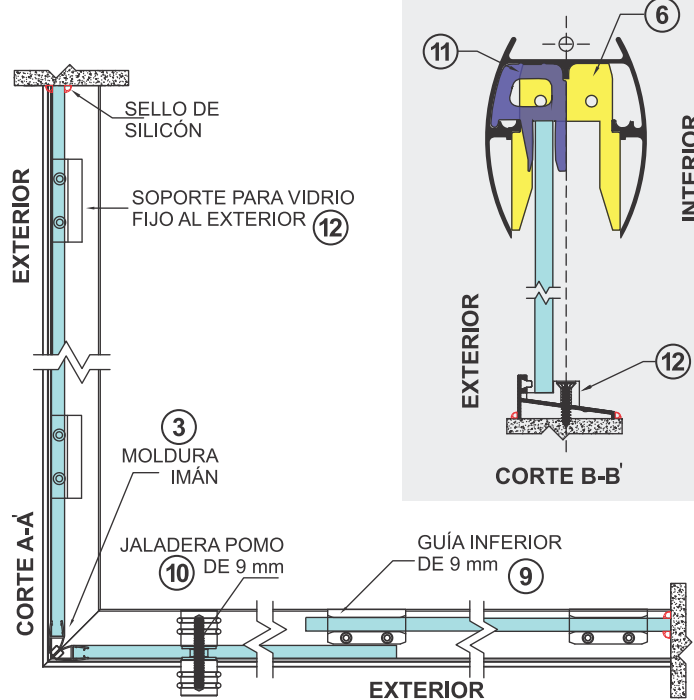

**CORTE LATERAL B-B'**

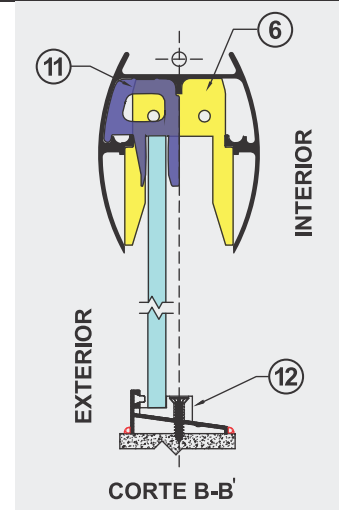

## Sistema Corredizo con Perfilera Perimetral

## Sistema Corredizo Línea Diamante



Cancel Recto  
Corredizo/Corredizo



Cancel Recto  
Corredizo/Corredizo



	<b>Riel Superior</b> PRS-LIB PRS-ESC	1 Pza		<b>Riel Superior</b> PRS-LIB PRS-ESC	1 Pza		
	<b>Jamba Lateral</b> PJL-LIG	2 Pzas		<b>Riel Inferior Transparente</b> PRI-TRNSP	1 Pza		
	<b>Riel Inferior</b> PRI-LIG	1 Pza		<b>Riel Inferior</b> ◆ PRI-LIG	1 Pza		
<b>Opcional</b>		<b>Carretilla Expuesta</b> CARREX09	4 Pzas	<b>Opcional</b>		<b>Carretilla Expuesta</b> CARREX09	4 Pzas
		<b>Carretilla Oculta</b> CARROC09	4 Pzas			<b>Carretilla Oculta</b> CARROC09	4 Pzas
	<b>Tope de Seguridad</b> TOPE SEG CARR	4 Pzas		<b>Tope de Seguridad</b> TOPE SEG CARR	4 Pzas		
	<b>Pijas y taquetes</b>	4 Jgos		<b>Pijas y taquetes</b>	4 Jgos		
	<b>Porta Jamba</b> PRT-RIEL	2 Pzas		<b>Soporte para Riel sin Jamba</b> SOP PRS SJL	2 Pzas		
	<b>Jaladera Pomo</b> JALPOMO 9MM	2 Jgos		<b>Jaladera Pomo</b> JALPOMO 9MM	2 Jgos		
	<b>Tope Lateral</b> JGO TOPETR 8-10	4 Pzas		<b>Moldura Burbuja</b> BURB 9MM	2 Pzas		
	<b>Guía Inferior</b> GUIA PLS 8-10MM	1 Pza		<b>Guía Inferior</b> GUIA PLS 8-10MM	1 Pza		

## Sistema Corredizo con Perfilera Perimetral

## Sistema Corredizo Línea Diamante



Cancel Recto  
Fijo Exterior/Corredizo



Cancel Recto  
Fijo Exterior/Corredizo



		<b>Riel Superior</b> PRS-LIB PRS-ESC	1 Pza			<b>Riel Superior</b> PRS-LIB PRS-ESC	1 Pza
		<b>Jamba Lateral</b> PJL-LIG	2 Pzas			<b>Riel Inferior Transparente</b> PRI-TRNSP	1 Pza
		<b>Riel Inferior</b> PRI-LIG	1 Pza			<b>Riel Inferior</b> ♦ PRI-LIG	1 Pza
Opcional		<b>Carretilla Expuesta</b> CARREX09	2 Pzas	Opcional		<b>Carretilla Expuesta</b> CARREX09	2 Pzas
		<b>Carretilla Oculta</b> CARROC09	2 Pzas			<b>Carretilla Oculta</b> CARROC09	2 Pzas
		<b>Tope de Seguridad</b> TOPE SEG CARR	2 Pzas			<b>Tope de Seguridad</b> TOPE SEG CARR	2 Pzas
		<b>Pijas y taquetes</b>	4 Jgos			<b>Pijas y taquetes</b>	4 Jgos
		<b>Porta Jamba</b> PRT-RIEL	2 Pzas			<b>Soporte para Riel sin Jamba</b> SOP PRS SJL	2 Pzas
		<b>Jaladera Pomo</b> JALPOMO 9MM	1 Jgo			<b>Jaladera Pomo</b> JALPOMO 9MM	1 Jgo
		<b>Tope Lateral</b> JGO TOPETR 8-10	4 Pzas			<b>Moldura Burbuja</b> BURB 9MM	1 Pza
		<b>Guía Inferior</b> GUIA PLS 8-10MM	1 Pza			<b>Guía Inferior</b> GUIA PLS 8-10MM	1 Pza
		<b>Centrador</b> CENT 8-10MM	2 Pzas			<b>Centrador</b> CENT 8-10MM	2 Pzas
		<b>Soporte para Vidrio Fijo al Exterior</b> SOPFIJOEXT 8-10	2 Pzas			<b>Soporte para Vidrio Fijo al Exterior</b> SOPFIJOEXT 8-10	2 Pzas

## Sistema Corredizo con Perfilera Perimetral

## Sistema Corredizo Línea Diamante



Cancel Recto  
Corredizo/Fijo Interior



Cancel Recto  
Corredizo/Fijo Interior



	<b>Riel Superior</b> PRS-LIB PRS-ESC	1 Pza		<b>Riel Superior</b> PRS-LIB PRS-ESC	1 Pza		
	<b>Jamba Lateral</b> PJL-LIG	2 Pzas		<b>Riel Inferior Transparente</b> PRI-TRNSP	1 Pza		
	<b>Riel Inferior</b> PRI-LIG	1 Pza		<b>Riel Inferior</b> ♦ PRI-LIG	1 Pza		
<b>Opcional</b>		<b>Carretilla Expuesta</b> CARREX09	2 Pzas	<b>Opcional</b>		<b>Carretilla Expuesta</b> CARREX09	2 Pzas
		<b>Carretilla Oculta</b> CARROC09	2 Pzas			<b>Carretilla Oculta</b> CARROC09	2 Pzas
	<b>Tope de Seguridad</b> TOPE SEG CARR	2 Pzas		<b>Tope de Seguridad</b> TOPE SEG CARR	2 Pzas		
	<b>Pijas y taquetes</b>	4 Jgos		<b>Pijas y taquetes</b>	4 Jgos		
	<b>Porta Jamba</b> PRT-RIEL	2 Pzas		<b>Soporte para Riel sin Jamba</b> SOP PRS SJL	2 Pzas		
	<b>Jaladera Pomo</b> JALPOMO 9MM	1 Jgo		<b>Jaladera Pomo</b> JALPOMO 9MM	1 Jgo		
	<b>Tope Lateral</b> JGO TOPETR 8-10	4 Pzas		<b>Moldura Burbuja</b> BURB 9MM	1 Pza		
	<b>Guía Inferior</b> GUIA PLS 8-10MM	1 Pza		<b>Guía Inferior</b> GUIA PLS 8-10MM	1 Pza		
	<b>Centrador</b> CENT 8-10MM	2 Pzas		<b>Centrador</b> CENT 8-10MM	2 Pzas		
	<b>Guía para Vidrio Fijo al Interior</b> GUIA PLS 8-10MM	1 Pza		<b>Guía para Vidrio Fijo al Interior</b> GUIA PLS 8-10MM	1 Pza		

## Sistema Corredizo con Perfilera Perimetral

## Sistema Corredizo Línea Diamante



Cancel en Escuadra Fijo Exterior/Corredizo-Corredizo/Fijo Exterior



Cancel en Escuadra Fijo Exterior/Corredizo-Corredizo/Fijo Exterior

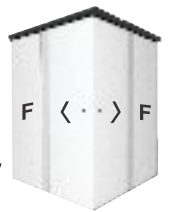

		<b>Riel Superior</b> PRS-LIB PRS-ESC	2 Pzas		<b>Riel Superior</b> PRS-LIB PRS-ESC	2 Pzas	
		<b>Jamba Lateral</b> PJL-LIG	2 Pzas		<b>Riel Inferior Transparente</b> PRI-TRNSP	2 Pzas	
		<b>Riel Inferior</b> PRI-LIG	2 Pzas		<b>Riel Inferior</b> ♦ PRI-LIG	2 Pzas	
<b>Opcional</b>		<b>Carretilla Expuesta</b> CARREX09	4 Pzas	<b>Opcional</b>		<b>Carretilla Expuesta</b> CARREX09	4 Pzas
		<b>Carretilla Oculta</b> CARROC09	4 Pzas			<b>Carretilla Oculta</b> CARROC09	4 Pzas
		<b>Tope de Seguridad</b> TOPE SEG CARR	4 Pzas		<b>Tope de Seguridad</b> TOPE SEG CARR	4 Pzas	
		<b>Pijas y taquetes</b>	4 Jgos		<b>Pijas y taquetes</b>	4 Jgos	
		<b>Porta Jamba</b> PRT-RIEL	2 Pzas		<b>Soporte para Riel sin Jamba</b> SOP PRS SJL	2 Pzas	
		<b>Jaladera Pomo</b> JALPOMO 9MM	2 Jgos		<b>Jaladera Pomo</b> JALPOMO 9MM	2 Jgos	
		<b>Tope Lateral</b> JGO TOPETR 8-10	4 Pzas		<b>Guía Inferior</b> GUIA PLS 8-10MM	1 Pza	
		<b>Guía Inferior</b> GUIA PLS 8-10MM	1 Pza		<b>Centrador</b> CENT 8-10MM	4 Pzas	
		<b>Centrador</b> CENT 8-10MM	4 Pzas		<b>Soporte para Vidrio Fijo al Exterior</b> SOPFIJOEXT 8-10	4 Pzas	
		<b>Soporte para Vidrio Fijo al Exterior</b> SOPFIJOEXT 8-10	4 Pzas		<b>Escuadra para Riel Superior</b> ESC2 PBAÑO	1 Pza	
		<b>Soporte para Riel Superior con Jamba</b> SOP PRS CJL	2 Pzas		<b>Escuadra para Riel Inferior</b> ESC INFTR PBAÑO	1 Pza	
		<b>Escuadra para Riel Superior</b> ESC2 PBAÑO	1 Pza		<b>Guía para Traslape</b> GUIA PLS 8-10MM	1 Pza	
		<b>Escuadra para Riel Inferior</b> ESC INF PBAÑO	1 Pza		<b>Moldura Imán</b> PP MAGN90 9MM Se vende por Separado	2 Pzas	
		<b>Guía para Traslape</b> GUIA PLS 8-10MM	1 Pza				
		<b>Moldura Imán</b> PP MAGN90 9MM Se vende por Separado	2 Pzas				

## Sistema Corredizo con Perfilera Perimetral

## Sistema Corredizo Línea Diamante



Cancel en Escuadra Fijo Interior/Corredizo-Corredizo/Fijo Interior



Cancel en Escuadra Fijo Interior/Corredizo-Corredizo/Fijo Interior

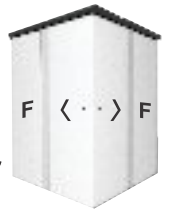

		<b>Riel Superior</b> PRS-LIB PRS-ESC	2 Pzas		<b>Riel Superior</b> PRS-LIB PRS-ESC	2 Pzas	
		<b>Jamba Lateral</b> PJL-LIG	2 Pzas		<b>Riel Inferior Transparente</b> PRI-TRNSP	2 Pzas	
		<b>Riel Inferior</b> PRI-LIG	2 Pzas		<b>Riel Inferior</b> ♦ PRI-LIG	2 Pzas	
Opcional		<b>Carretilla Expuesta</b> CARREX09	4 Pzas	Opcional		<b>Carretilla Expuesta</b> CARREX09	4 Pzas
		<b>Carretilla Oculta</b> CARROC09	4 Pzas			<b>Carretilla Oculta</b> CARROC09	4 Pzas
		<b>Tope de Seguridad</b> TOPE SEG CARR	4 Pzas		<b>Tope de Seguridad</b> TOPE SEG CARR	4 Pzas	
		<b>Pijas y taquetes</b>	4 Jgos		<b>Pijas y taquetes</b>	4 Jgos	
		<b>Porta Jamba</b> PRT-RIEL	2 Pzas		<b>Soporte para Riel sin Jamba</b> SOP PRS SJL	2 Pzas	
		<b>Jaladera Pomo</b> JALPOMO 9MM	2 Jgos		<b>Jaladera Pomo</b> JALPOMO 9MM	2 Jgos	
		<b>Tope Lateral</b> JGO TOPETR 8-10	4 Pzas		<b>Guía Inferior</b> GUIA PLS 8-10MM	1 Pza	
		<b>Guía Inferior</b> GUIA PLS 8-10MM	1 Pza		<b>Centrador</b> CENT 8-10MM	4 Pzas	
		<b>Centrador</b> CENT 8-10MM	4 Pzas		<b>Escuadra para Riel Superior</b> ESC2 PBAÑO	1 Pza	
		<b>Soporte para Riel Superior con Jamba</b> SOP PRS CJL	2 Pzas		<b>Escuadra para Riel Inferior</b> ESC INFTR PBAÑO	1 Pza	
		<b>Escuadra para Riel Superior</b> ESC2 PBAÑO	1 Pza		<b>Guía para Vidrio Fijo al Interior</b> GUIA PLS 8-10MM	3 Pzas	
		<b>Escuadra para Riel Inferior</b> ESC INF PBAÑO	1 Pza		<b>Moldura Imán</b> PP MAGN90 9MM Se vende por Separado	2 Pzas	
		<b>Guía para Vidrio Fijo al Interior</b> GUIA PLS 8-10MM	3 Pzas				
		<b>Moldura Imán</b> PP MAGN90 9MM Se vende por Separado	2 Pzas				

## Sistema Corredizo con Perfilera Perimetral



**Cancel en Escuadra Fijo Exterior-Corredizo/ Fijo Interior**

## Sistema Corredizo Línea Diamante



**Cancel en Escuadra Fijo Exterior-Corredizo/ Fijo Interior**

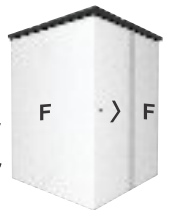

		<b>Riel Superior</b> PRS-LIB PRS-ESC	2 Pzas		<b>Riel Superior</b> PRS-LIB PRS-ESC	2 Pzas
		<b>Jamba Lateral</b> PJL-LIG	2 Pzas		<b>Riel Inferior Transparente</b> PRI-TRNSP	2 Pzas
		<b>Riel Inferior</b> PRI-LIG	2 Pzas		<b>Riel Inferior</b> ♦ PRI-LIG	2 Pzas
<b>Opcional</b>		<b>Carretilla Expuesta</b> CARREX09	2 Pzas		<b>Carretilla Expuesta</b> CARREX09	2 Pzas
		<b>Carretilla Oculta</b> CARROC09	2 Pzas		<b>Carretilla Oculta</b> CARROC09	2 Pzas
		<b>Tope de Seguridad</b> TOPE SEG CARR	2 Pzas		<b>Tope de Seguridad</b> TOPE SEG CARR	2 Pzas
		<b>Pijas y taquetes</b>	4 Jgos		<b>Pijas y taquetes</b>	4 Jgos
		<b>Porta Jamba</b> PRT-RIEL	2 Pzas		<b>Soporte para Riel sin Jamba</b> SOP PRSS SJL	2 Pzas
		<b>Jaladera Pomo</b> JALPOMO 9MM	1 Jgo		<b>Jaladera Pomo</b> JALPOMO 9MM	1 Jgo
		<b>Tope Lateral</b> JGO TOPETR 8-10	4 Pzas		<b>Guía para Vidrio Fijo al Interior</b> GUIA PLS 8-10MM	2 Pzas
		<b>Guía para Vidrio Fijo al Interior</b> GUIA PLS 8-10MM	2 Pzas		<b>Centrador</b> CENT 8-10MM	4 Pzas
		<b>Centrador</b> CENT 8-10MM	4 Pzas		<b>Escuadra para Riel Superior</b> ESC2 PBAÑO	1 Pza
		<b>Soporte para Riel Superior con Jamba</b> SOP PRS CJL	2 Pzas		<b>Escuadra para Riel Inferior</b> ESC INFTR PBAÑO	1 Pza
		<b>Escuadra para Riel Superior</b> ESC2 PBAÑO	1 Pza		<b>Soporte para Vidrio Fijo al Exterior</b> SOPFIJOEXT 8-10	2 Pzas
		<b>Escuadra para Riel Inferior</b> ESC INF PBAÑO	1 Pza		<b>Moldura Imán</b> PP MAGN90 9MM Se vende por Separado	2 Pzas
		<b>Soporte para Vidrio Fijo al Exterior</b> SOPFIJOEXT 8-10	2 Pzas			
		<b>Moldura Imán</b> PP MAGN90 9MM Se vende por Separado	2 Pzas			



**INTEGRAGLASS EXTIENDE LA EXPERIENCIA EN TU BAÑO, EVITANDO HONGOS Y DECOLORAMIENTO ACELERADO.**

**VALOR AGREGADO**



# Posición y Diámetros de Barrenos

Compatible con:

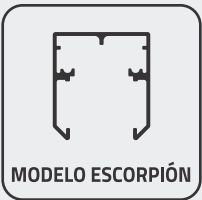
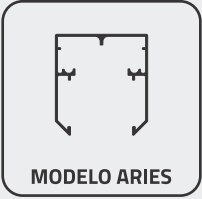

## Jaladera Pomo

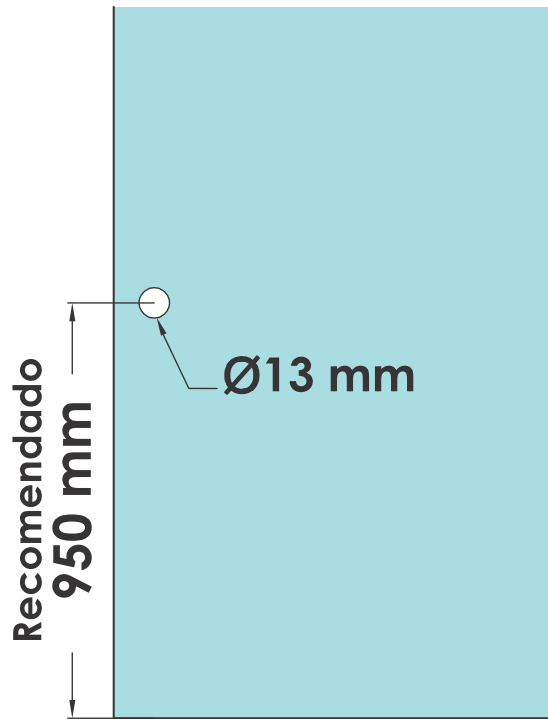

## Toallero

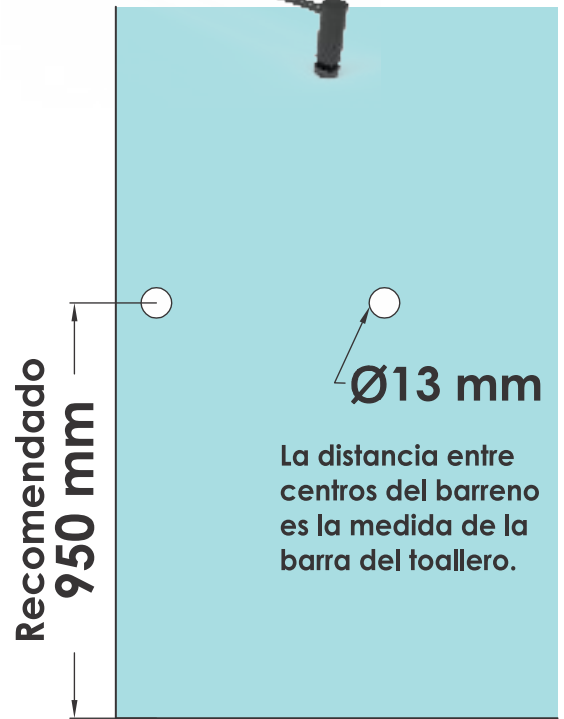

## Carretilla Oculta

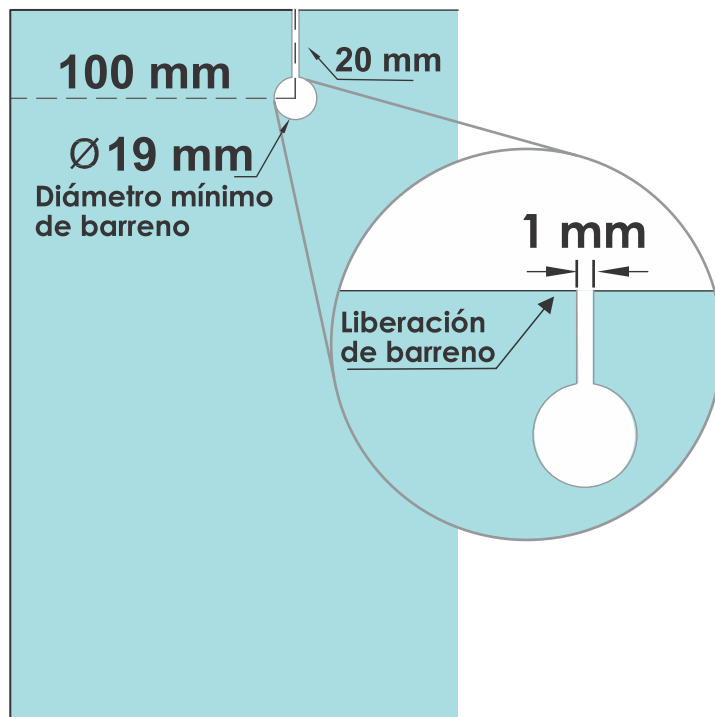

## Carretilla Expuesta



# Accesorios Toallero para vidrio templado sin barreno

**AI**  
ALUMINIO

**25**  
ACABADOS

**D**  
DOBLE VISTA

**Nuevo**

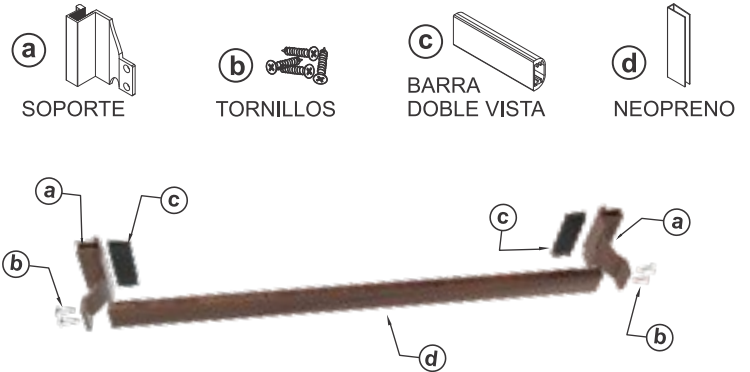

## Toallero sin Barreno Rectangular

TOA6MC SB

Pijas con Acabado



## Toallero sin Barreno Redondo

TOA6MR SB

Pijas con Acabado



## Jaladera sin Barreno

JAL SB PRE6MM

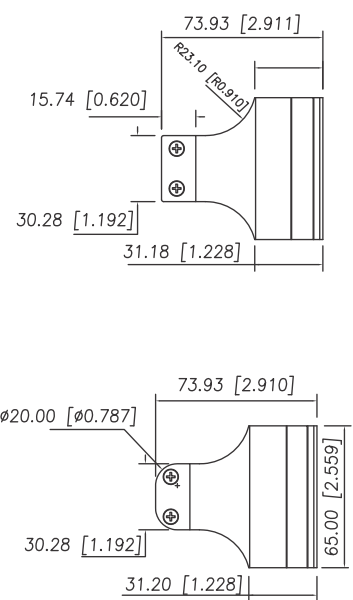
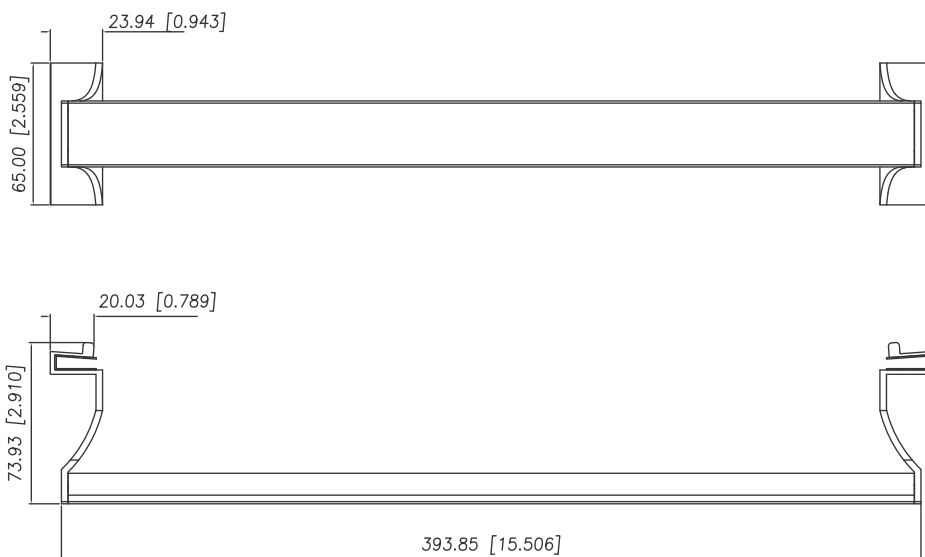

# Accesorios Toallero para vidrio templado con barreno



## Toallero con Barreno de 50 cm

TOA50 6MM

TOA50 9MM



## Toallero con Barreno de 70 cm

TOA70 6MM

TOA70 9MM

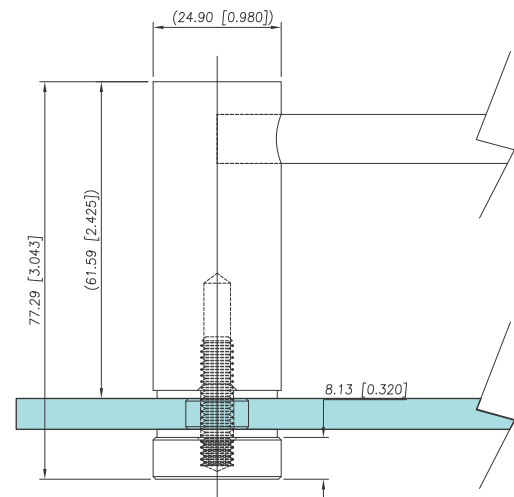
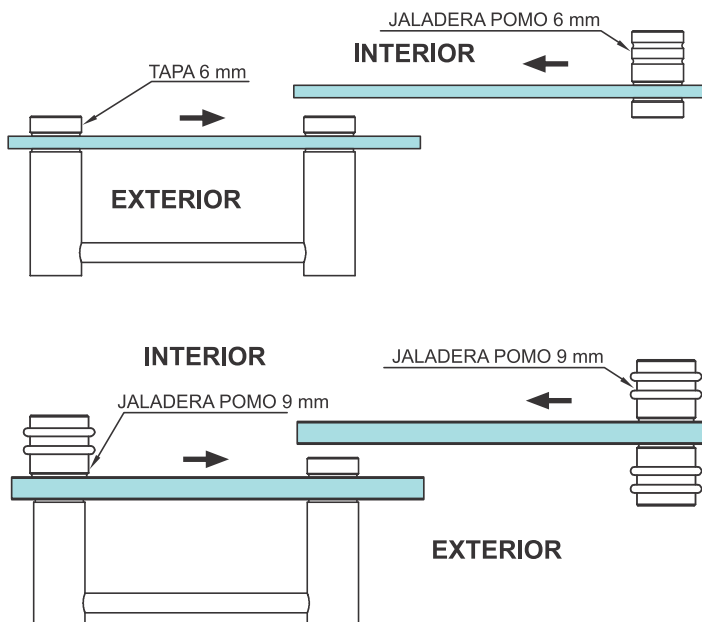

# CONTAMOS CON **25 ACABADOS** DE LÍNEA.

## SUBLIMADOS

Chocolate  
Texturizado

Maple  
Texturizado

Nogal Rojizo  
Liso

Nogal Oscuro  
Texturizado

Fresno  
Texturizado

Bosque  
Texturizado

Abedul  
Texturizado

Pino  
Texturizado

Roble  
Texturizado

Palo de Rosa  
Texturizado

## ANODIZADOS

Champagne  
Inox Brillante

Champagne  
Brillante Liso

Bronce Oscuro  
Brillante Liso

Bronce Oscuro  
Mate Liso

Bronce Brillante  
Liso

Bronce Mate  
Liso

Natural  
Mate Liso

Natural  
Brillante Liso

Inox Satin

Champagne Mate

## PINTURA ELECTROSTÁTICA

Gris Europa  
Liso

Negro semi  
Mate Liso

Duro E Liso

Hueso Liso

Blanco Liso



## Videos Personalizados

Personalización de nuestros videos de instalación y accesorios.



## Capacitación

Capacitamos a la fuerza de ventas de nuestros Distribuidores.



## Exhibidor de Acabados

Torre para exhibición con nuestros 25 acabados de linea.



## Exhibidor de Sistemas

Obtén tu exhibidor de cualquiera de nuestros modelos para cancel de baño.



## USB

Ponemos a tu disponibilidad toda la información de nuestros productos.



## Formatos

Adaptación de diseños en formatos para correo y whatsapp.

## Beneficios Comerciales

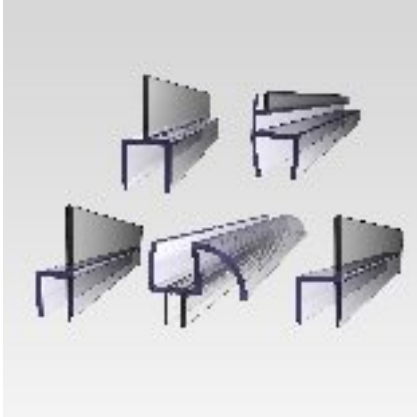

### Muestrarios

Molduras de imán y nacionales, disponibles para vidrio de 6 mm y de 8 a 10 mm.



### Catálogo Impreso

Personalización de nuestros catálogos de productos y accesorios.



### Promotoria

Promovemos y asesoramos nuestros valores competitivos con los clientes directos de Distribuidores.



### Promos Digitales

Personalización de promos digitales de productos.



### Productos Comerciales

Contamos con una amplia gama de productos para sistemas corredizos.

# ¡Descubre! más

Visita nuestra pagina  
[www.integraglass.com.mx](http://www.integraglass.com.mx)  
o escanea el siguiente código QR, y  
descubre más de nuestros sistemas  
corredizos para vidrio templado.

---



Escanea el siguiente código  
QR para ver nuestro video de  
instalación de Cancel recto  
doble corredizo.

---

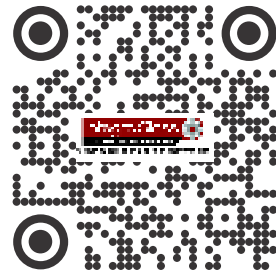

Escanea el siguiente código  
QR para ver nuestro video de  
instalación de Cancel en Escuadra.

---

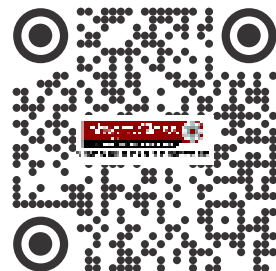

Distribuido por



Sistemas corredizos para cancel de baño.

IntegraGlass® 

Fabricación de herrajes para vidrio

Sistemas corredizos para cristal templado

